

2021 TECHNICAL DATABOOK

TOURANCE™ NEXT 2

Range

SEGMENT DEFINITION	4
APPLICATION CHART	6
RACING	8
SPORT	16
SPORT TOURING	20
CRUISING	28
ENDURO STREET	34
ENDURO ON/OFF	38
ENDURO OFF ROAD / MOTOCROSS	42
MOUSSE	46
SCOOTER	48

Technical Information

TUBE AND VALVE FITMENT CHART	52
MARKING AND DESIGNATION SYSTEM	58
A CLOSER LOOK AT METZELER MOTORCYCLE TECHNOLOGY	59
TYRE SAFETY MAINTENANCE AND MOUNTING ADVICE	60
TECHNICAL DATA TO STANDARD	64
COMPARATIVE CHART	72
LOAD INDEX AND SPEED INDEX	73

With this edition all previous editions become void.
 Technical alterations reserved!
 We would like to point out that we have made the tyre and pressure
 recommendations for the individual motorcycle types to the best of our
 knowledge, but without assuming any liability for them.



Safety Warning
 Danger may result from improper use.
 Follow the manufacturer's instructions.

Warning
 The tyres represented in this book are for use only on vehicles for which
 the "motorcycle tyres" were originally specified by the manufacturer.
 Any other use could be dangerous.

follow metzelermoto





RIDE THE UNEXPECTED.

INTRODUCING THE NEW SPORTEC™ M9 RR.

Excellent performance in the wet, dry and through every corner.

Find out more at: www.metzeler.com



METZELER 
MOTORCYCLE TYRES

Sportec™
M9 RR

RACING

Page 11 - 12



RACING PRO
SUPERBIKE

RACETEC™ RR
SLICK

RACETEC™ RR
RAIN

RACETEC™ RR
INTERMEDIATE



RACING

Page 13 - 15

RACING PRO

TRACK DAYS

SUPERMOTO

SUPERSPORT

RACETEC™ SM

RACETEC™ SM RAIN

RACETEC™ RR

RACETEC™ TD
SLICK



SPORT

Page 17 - 19

SPORTEC™ M9 RR

SPORTEC™ M7 RR

SPORTEC™ M5
INTERACT™

SPORTEC™
STREET



SPORT TOURING

Page 22 - 25

ROADTEC™ 01 SE

ROADTEC™ 01

ROADTEC™ Z8
INTERACT™

ROADTEC™ Z6



TOURING

Page 26 - 27

LASERTEC™

ME 22™

PERFECT ME 11™

BLOCK™ K

BLOCK™ C

CRUISING

Page 30 - 33

PERFECT ME 77

ME 888
MARATHON™ ULTRA

CRUISETEC™



ENDURO STREET

Page 36 - 37



TOURANCE™ NEXT 2

TOURANCE™

ENDURO 1 & 2

ENDURO ON/OFF

Page 40 - 41



KAROO™ STREET

KAROO™ 3

KAROO™ EXTREME

ENDURO 3 SAHARA

ENDURO OFF ROAD

Page 44



MCE 6 DAYS EXTREME

MOTOCROSS

Page 45



MC360™ MID SOFT

MC360™ MID HARD

MOUSSE & GEL

Page 46 - 47



SCOOTER





Page 48 - 51



ROADTEC™ SCOOTER







FEELFREE™

SPORTEC™ STREET

		MOTORCYCLE				
TYRE SEGMENTATION	SUPERBIKE & SUPERSPORT	NAKED	SUPERMOTO	SPORT TOURER		
						
RACING	RACETEC™ RR SLICK					
	RACETEC™ RAIN					
	RACETEC™ INTERMEDIATE					
			RACETEC™ SM			
			RACETEC™ SM RAIN			
	RACETEC™ TD SLICK					
SPORT	RACETEC™ RR K1, K2					
	RACETEC™ RR K3					
	SPORTEC™ M9 RR					
	SPORTEC™ M7 RR					
	SPORTEC™ M5 INTERACT™					
	SPORTEC™ STREET					
SPORT TOURING	ROADTEC™ 01 & ROADTEC™ 01 SE					
		ROADTEC™ Z8 INTERACT™				
		ROADTEC™ Z6				
TOURING		LASERTEC™				
				ME22, 11, BLOCK K AND BLOCK C		
CRUISING & TOURING						
ENDURO STREET						
ENDURO ON/OFF						
OFF-ROAD						
SCOOTER						

FIRST LINES

SECOND LINES

	CLASSIC & SCRAMBLER 	ADVENTURE 	ENDURO 	CROSS 	CRUISER AND TOURER 	SCOOTER 
	RACETEC™ RR K1, K2					
		SPORTEC™ M9 RR				
					CRUISETEC™	
					ME 888	
					MARATHON	
					ULTRA	
					PERFECT ME 77	
		TOURANCE™				
		TOURANCE™ NEXT 2				
		TOURANCE™				
		ENDURO 1, ENDURO 2				
	KAROO™ STREET					
	KAROO™ 3					
		KAROO™ EXTREME				
	ENDURO 3 SAHARA					
			6 DAYS EXTREME			
			MC360 (MID SOFT & MID HARD)			
						ROADTEC™ SCOOTER
						FEELFREE™
						SPORTEC™ STREET

RACING



MOTORCYCLE					
TYRE SEGMENTATION	SUPERBIKE & SUPERSPORT	NAKED	SUPERMOTO	SPORT TOURER	CLASSIC & SCRAMBLER
RACING	RACETEC™ RR SLICK				
	RACETEC™ RAIN				
	RACETEC™ INTERMEDIATE				
			RACETEC™ SM		
			RACETEC™ SM RAIN		
	RACETEC™ TD SLICK				
	RACETEC™ RR K1, K2				RACETEC™ RR K1, K2
SPORT	RACETEC™ RR K3				

COMPOUND CHOICE

REAR TYRE

RIDING STYLE

A committed riding style raises the tyre operating temperature and can lead to using a softer compound, whilst a smooth riding style reduces the amount of heat generation, thus requiring a harder compound.

OPERATING TEMPERATURE

A softer compound requires an higher operating temperature range than a harder compound.

ASPHALT ROUGHNESS

A rough asphalt requires a hard compound whilst a smooth asphalt tends to preserve a softer compound.

Using the right compound enables

- 👍 Performance Optimum
- 👍 Even wear
- 👍 No blisters
- 👍 No grains
- 👍 Consistent performance

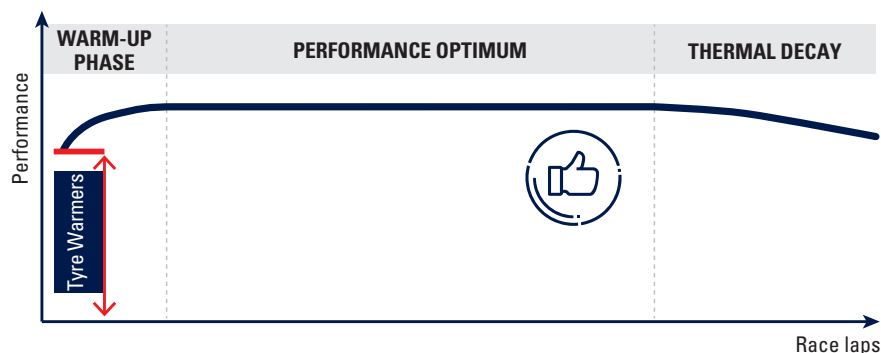

Using a too hard compound in

AGGRESSIVE riding style
HOT operating temperature
SMOOTH asphalt

- 👎 Inconsistent performance
- 👎 Shortened lifespan

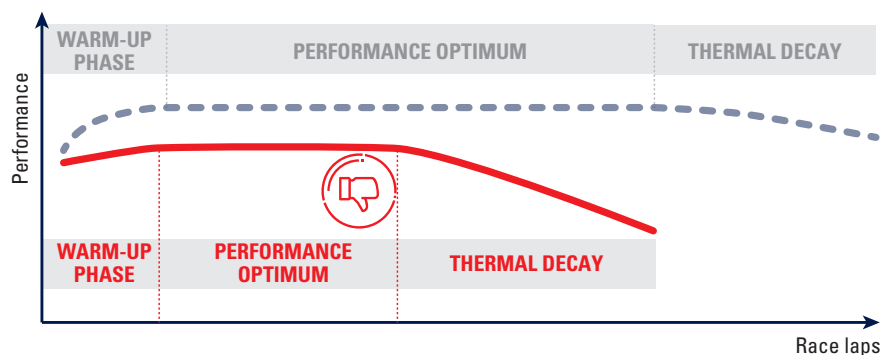

Using a too soft compound in

SMOOTH riding style
COOL operating temperature
ROUGHING asphalt

- 👎 Cold-tearing
- 👎 Performance drop
- 👎 Shortened lifespan

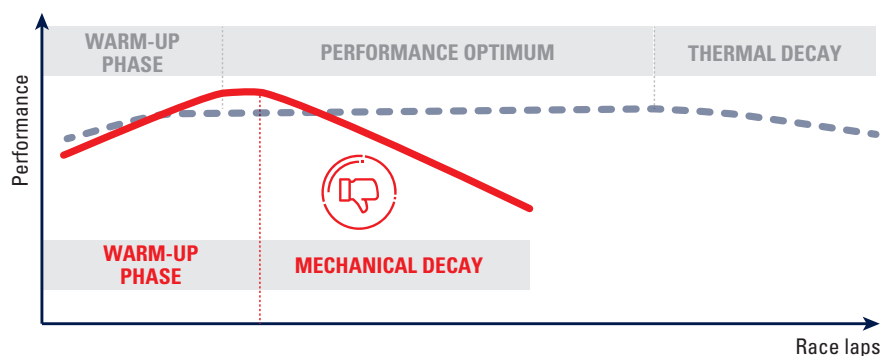

Tips for tyre pressure and warmers

NHS Slick tyres - RACETEC™ RR SLICK, RACETEC™ TD SLICK, RACETEC™ SM

F/R	RIM	SIZE	RECOMMENDED RIM SIZE [in.]	RECOMMENDED COLD PRESSURE (W/O TYRE WARMERS) [bar] (psi)	RECOMMENDED HOT PRESSURE (AFTER TYRE WARMERS) [bar] (psi)	TYRE WARMERS GUIDELINES
FRONT	16,5"	125/75 R420	3.50	1.6/1.8 (23/26)	1.7/1.9 (25/28)	40min @ 80°C (176°F)
	17"	120/70 R17		2.1/2.2 (30/32)	2.2/2.5 (32/36)	50min @ 80°C (176°F)
		125/70 R17		1.6/1.8 (23/26)	1.7/1.9 (25/28)	40min @ 80°C (176°F)
REAR	17"	165/55 R17	5.00 – 6.00	1.5/1.6 (22/23)	1.6/1.7 (23/25)	40min @ 80°C (176°F)
		180/55 R17	5.50			
		180/60 R17	5.50 – 6.00			
		190/55 R17	5.50 – 6.00			
		200/55 R17	6.00			
		200/60 R17	6.00			

NHS Slick tyres - RACETEC™ RR RAIN, RACETEC™ RR INTERMEDIATE, RACETEC™ SM RAIN

F/R	RIM	SIZE	RECOMMENDED RIM SIZE [in.]	RECOMMENDED COLD PRESSURE (W/O TYRE WARMERS) [bar] (psi)	RECOMMENDED HOT PRESSURE (AFTER TYRE WARMERS) [bar] (psi)	TYRE WARMERS GUIDELINES
FRONT	17"	120/70 R17	3.50	2.3 (34)	2.4 (35)	30min @ 80°C (176°F)
REAR	17"	165/55 R17	5.50	1.9 (28)	2.0 (29)	
		190/60 R17	5.50 – 6.00			

Street Legal tyres - RACETEC™ RR

F/R	RIM	SIZE	RECOMMENDED RIM SIZE [in.]	RECOMMENDED COLD PRESSURE (W/O TYRE WARMERS) [bar] (psi)	RECOMMENDED HOT PRESSURE (AFTER TYRE WARMERS) [bar] (psi)	TYRE WARMERS GUIDELINES
FRONT	17"	120/70 ZR17	3.50	2.0/2.2 (29/32)	2.1/2.4 (30/35)	50min @ 80°C (176°F)
	18"	110/80 ZR18				
REAR	17"	180/55 ZR17	5.50	1.6/1.8 (23/26)	1.7/1.9 (25/28)	50min @ 80°C (176°F)
		180/60 ZR17	5.50 – 6.00			
		190/55 ZR17	5.50 - 6.00			
		200/55 ZR17	6.00			
	18"	130/80 ZR18	5.50			
		150/65 ZR18	5.50 – 6.00			
		160/60 ZR18	5.50 - 6.00			

METZELER professional racing slick tyres, the winner of 2019 Senior TT

- High-intensity adherence, agility and predictability at all stages thanks to racing profiles and state-of-the-art technology compounds
- Trajectory precision and superb high-speed stability developed over the toughest Road Races
- Performance consistency, lap after lap or over the course of lengthy road races
- New K2 compound, designed to deliver remarkable performance consistency over multiple and diverse track sessions



FRONT SIZE	SPECIAL VERSION	IP CODE	NOTE
17 120/70 R 17 NHS TL	K1	2698500	NEW SPEC
120/70 R 17 NHS TL	K2	2698600	NEW SPEC

REAR SIZE	SPECIAL VERSION	IP CODE	NOTE
17 180/60 R 17 NHS TL	K1	2698700	
180/60 R 17 NHS TL	K2	2698800	
200/60 R 17 NHS TL	K0	3656700	
200/60 R 17 NHS TL	K1	2698900	
200/60 R 17 NHS TL	K2	2699000	

TL = Tubeless
NHS = Not for Highway Service

FRONT SPECIFICATION CHOICE

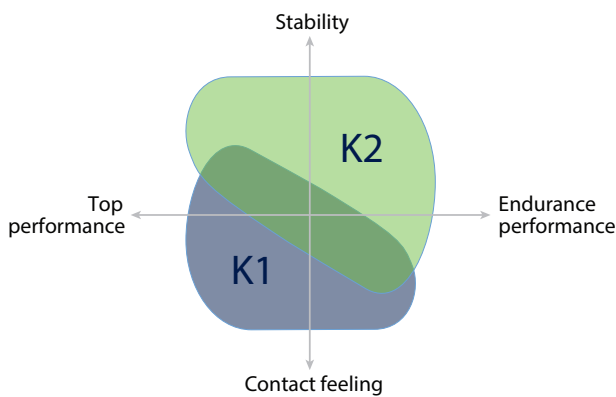

REAR SPECIFICATION CHOICE

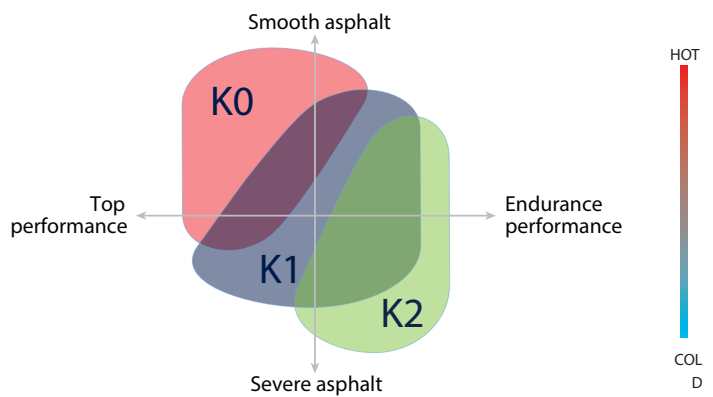

Note: Temperature scale refers to tyre operating temperature. Compound choice can vary depending on bike setup and riding style. Please check with your dealer or racing service.

K0 = Super Soft
K1 = Soft
K2 = Medium

Racetec™

RR RAIN



NHS Competition tyres for severe wet conditions

- Deep tread grooves for efficient water evacuation
- 100% Silica compound for grip on extreme wet conditions
- Superb traction and stability at high speed

FRONT SIZE	SPECIAL VERSION	IP CODE	NOTE
17 120/70 R 17 NHS TL	KR1	3310800	

REAR SIZE	SPECIAL VERSION	IP CODE	NOTE
17 190/60 R 17 NHS TL	KR1	3310900	

TL = Tubeless
NHS = Not for Highway Service

Racetec™

RR INTERMEDIATE



NHS Competition tyre for damp (intermediate) racing conditions

- Exclusive compound formulation for fast warm-up and versatility of use
- Performance and control in Intermediate weather conditions
- Regular wear without loss in any kind of performance
- Excellent traction and stability at high speed

FRONT SIZE	SPECIAL VERSION	IP CODE	NOTE
17 120/70 R 17 NHS TL	KI1	3311100	

REAR SIZE	SPECIAL VERSION	IP CODE	NOTE
17 190/60 R 17 NHS TL	KI1	3311200	

TL = Tubeless
NHS = Not for Highway Service

Racetec™ line tyre specialised for supermoto. Advanced racing compounds and profile for the most effective straight and sideways riding

- Superb line holding and excellent steering precision while braking
- Fast warm-up, immediate self-cleaning
- Silica compounds for quick warm-up and optimised abrasion resistance
- Extra mechanical grip provided for off-road track sections



FRONT SIZE	SPECIAL VERSION	IP CODE	NOTE
16.5 125/75 R 420 NHS TL	K1	2542100	NEW SPEC
125/75 R 420 NHS TL	K2	2542200	NEW SPEC
17 125/75 R 17 NHS TL	K1	3904700	NEW SPEC
125/75 R 17 NHS TL	K2	3904800	NEW SPEC

REAR SIZE	SPECIAL VERSION	IP CODE	NOTE
17 165/55 R 17 NHS TL	K0	2730800	NEW SPEC
165/55 R 17 NHS TL	K1	2730900	
165/55 R 17 NHS TL	K2	2731000	

TL = Tubeless
NHS = Not for Highway Service

FRONT SPECIFICATION CHOICE

REAR SPECIFICATION CHOICE

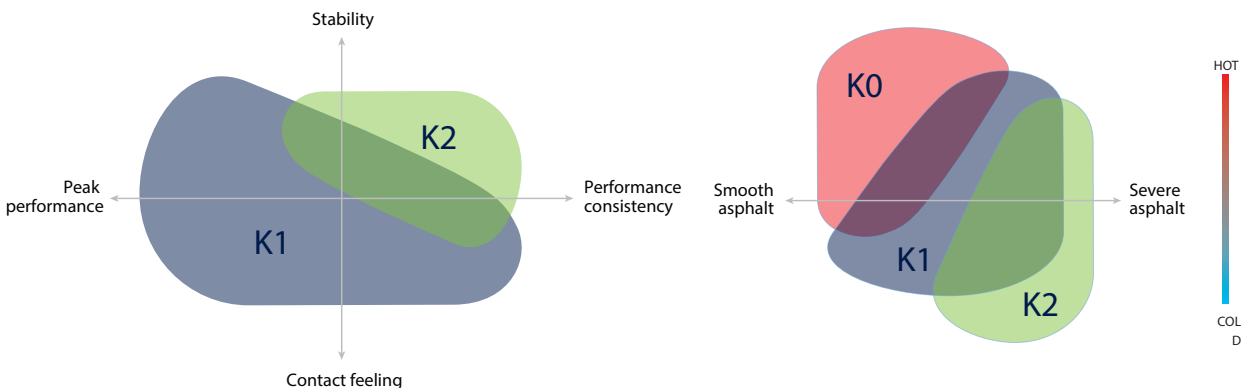

Note: Temperature scale refers to tyre operating temperature. Compound choice can vary depending on bike setup and riding style. Please check with your dealer or racing service.

K0 = Super Soft
K1 = Soft
K2 = Medium

METZELER racing expertise developed for Supermotard racing in severe wet conditions

- State-of technology Silica-based compounds for immediate warm-up and extreme chemical grip
- Tread design contributes to mechanical grip offering immediate self-cleaning and mechanical grip

FRONT SIZE	SPECIAL VERSION	IP CODE	NOTE
16.5 125/75 R 420 NHS TL		2812800	
17 125/75 R 17 NHS TL		2812900	

REAR SIZE	SPECIAL VERSION	IP CODE	NOTE
17 165/55 R 17 NHS TL		2813000	

TL = Tubeless
NHS = Not for Highway Service





Feel the RRace, feel the RRoad

- High-intensity adherence, agility and predictability at all stages thanks to racing profiles and state-of-the-art technology compounds developed in road legal specifications
- Trajectory precision and superb high-speed stability developed over the toughest Road Races
- New K2 compound, designed to deliver remarkable performance consistency over multiple and diverse track sessions
- 18 inches sizes developed for classic racing
- K3 the endurance-oriented version of RACETEC™ RR treaded racing tyres, featuring dual compound rears for top lateral grip and extended duration

FRONT SIZE	SPECIAL VERSION	IP CODE	NOTE
17 120/70 ZR 17 M/C (58W) TL	K1	2548300	
120/70 ZR 17 M/C (58W) TL	K2	2548400	
120/70 ZR 17 M/C (58W) TL	K3	2525700	
18 110/80 ZR 18 M/C (58W) TL	K1	2854500	CLASSIC RACING

REAR SIZE	SPECIAL VERSION	IP CODE	NOTE
17 160/60 ZR 17 M/C (69W) TL	K2	2548500	
160/60 ZR 17 M/C (69W) TL	K3	2525800	
180/55 ZR 17 M/C (73W) TL	K2	2548600	
180/55 ZR 17 M/C (73W) TL	K3	2525900	
180/60 ZR 17 M/C (75W) TL	K1	2548700	
180/60 ZR 17 M/C (75W) TL	K2	2548800	
190/50 ZR 17 M/C (73W) TL	K3	2526000	
190/55 ZR 17 M/C (75W) TL	K1	3888100	
190/55 ZR 17 M/C (75W) TL	K2	3888200	
190/55 ZR 17 M/C (75W) TL	K3	2526100	
200/55 ZR 17 M/C (78W) TL	K1	3888300	NEW SPEC
200/55 ZR 17 M/C (78W) TL	K2	3888400	NEW SPEC
200/55 ZR 17 M/C (78W) TL	K3	3888500	NEW SPEC
18 130/80 ZR 18 M/C (66W) TL	K1	3427600	CLASSIC RACING
160/60 ZR 18 M/C (70W) TL	K1	2854600	CLASSIC RACING
150/65 ZR 18 M/C (69W) TL	K1	3272300	CLASSIC RACING

TL = Tubeless

FRONT SPECIFICATION CHOICE

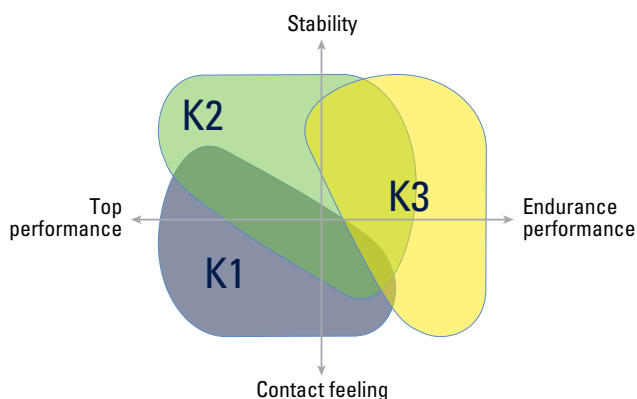

REAR SPECIFICATION CHOICE

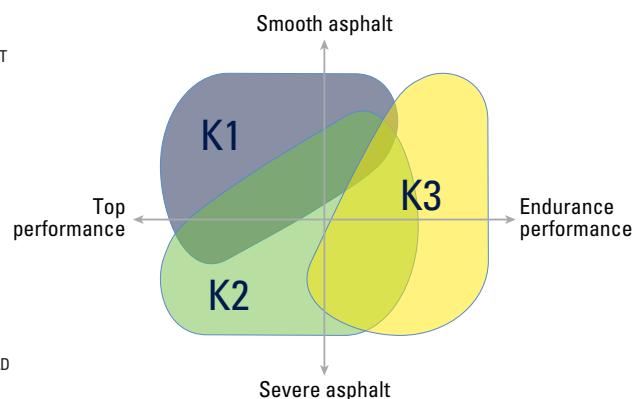

Note: Temperature scale refers to tyre operating temperature. Compound choice can vary depending on bike setup and riding style. Please check with your dealer or racing service.

K0 = Super Soft
K1 = Soft
K2 = Medium

Leave no track unraced

- Plug&Play racing fun
- Quick warm-up makes turns tyre warmers into an option
- Reusable along several sessions thanks to high thermal stress and cold tearing resistance
- Reversible rear tyres to exploit the last patch of rubber

FRONT SIZE	SPECIAL VERSION	IP CODE	NOTE
17 120/70 R 17 NHS TL		3895000	

REAR SIZE	SPECIAL VERSION	IP CODE	NOTE
17 180/55 R 17 NHS TL		3895100	
180/60 R 17 NHS TL		3942900	NEW
190/55 R 17 NHS TL		3895200	
200/55 R 17 NHS TL		3895300	

TL = Tubeless
NHS = Not for Highway Service



Motociclismo (IT)
Issue: 08/2020

"[...]the aspect that impressed us the most is their performance consistency over multiple track sessions, without having to resort to tyre warmers to keep the tyres at temperature."

bennetts.co.uk (UK)
published online 16th October 2020

"The turn-in is excellent, the feel is what you'd expect from a track day tyre, and I'm getting on the power earlier and earlier, trying, without success, to find the limits."

inmoto.it (IT)
published on 27th July 2020

"On a bike like the Honda Fireblade CBR 1000 RR-R, the Racetec TD kept up to the promise: neutral behaviour, lots of feeling and excellent grip at maximum inclinations and a lot of agility, both in changes of trajectory and when starting the lean."



SPORT



MOTORCYCLE

SUPERBIKE & SUPERSPORT



NAKED



SUPERMOTO



SPORT TOURER



ADVENTURE



SPORT

SPORTEC™ M9 RR

SPORTEC™ M7 RR

SPORTEC™ STREET

Ride the Unexpected

Latest update of the multiple test winner Sportec M7RR.

- Outstanding handling, for a great riding pleasure
- Quick warm-up, impressive wet response thanks to 100% silica compounds
- Plenty of grip since the first corner to hit your toughest challenges
- Cap&base dual compound layout delivers best performance throughout the entire tyre lifespan
- METZELER first Hypersport tyre in key adventure bike sizes: a breakthrough in BMW R/GS riding experience.

FRONT SIZE	SPECIAL VERSION	IP CODE	NOTE
17	110/70 R 17 M/C 54H TL	3627200	
	110/70 ZR 17 M/C 54W TL	3626600	
	120/70 ZR 17 M/C (58W) TL	3616900	
19	120/70 R 19 M/C 60V TL	3617500	NEW

REAR SIZE	SPECIAL VERSION	IP CODE	NOTE
17	140/70 R 17 M/C 66H TL	3627300	
	150/60 R 17 M/C 66H TL	3627400	
	150/60 ZR 17 M/C 66W TL	3626700	
	160/60 ZR 17 M/C (69W) TL	3617000	
	170/60 R 17 M/C 72V TL	3617600	NEW
	180/55 ZR 17 M/C (73W) TL	3617100	
	180/60 ZR 17 M/C (75W) TL	3626800	
	190/50 ZR 17 M/C (73W) TL	3617200	
	190/55 ZR 17 M/C (75W) TL	3617300	
	200/55 ZR 17 M/C (78W) TL	3617400	

TL = Tubeless



bikereview.com.au (AU)
published on 5th March 2020

SCORE OF 9.1 OUT OF 10 – EXCELLENT!

“Be assured that the M9 RRs played a pivotal role in really providing a bigger envelope for me to play in they felt rock solid even after multiple sessions of abuse beforehand. Exuberant.”

motorcycle.com (US)
published on 3rd March 2020

“Within a mile or so, I felt comfortable bending the MT 07 I had for the street ride into the corners without concern. As the pace hotted up and the ambient temperature climbed, I never gave grip a second thought.”

Motociclismo (IT)
Issue: 04/2020

“Excellent on the road, the Metzeler SportecM9 RR also perform very well on the circuit. A lot of confidence given by the front and perfect balance with the rear.”

motorcyclenews.com
published on 3rd March 2020

“Fitted to our S1000XR test bike they help carve out assured, accurate lines straight to an apex. Just pick a line and boom, the BMW darts there, transforming this sports adventure into a crisp, svelte steering sportsbike.”





Wet roads, dry roads. Just ride it.
Engineered to empower true riders

- Dedicated to all riders with a sporty riding style, looking for grip in any road condition, weather and temperature
- The first supersport tyre introducing a new paradigm of contact feeling on wet
- Dual-compound rear, combined with INTERACT™ technology
- Profiles and Structures derived from METZELER expertise in Road Races

FRONT SIZE	SPECIAL VERSION	IP CODE	NOTE
16 130/70 ZR 16 M/C (61W) TL		3865600	NEW
17 110/70 ZR 17 M/C 54W TL		2449800	
120/60 ZR 17 M/C (55W) TL		2449900	
120/70 ZR 17 M/C (58W) TL	(M)	2520800	

REAR SIZE	SPECIAL VERSION	IP CODE	NOTE
17 150/60 ZR 17 M/C 66W TL		2450100	
160/60 ZR 17 M/C (69W) TL		2450200	
180/55 ZR 17 M/C (73W) TL		2450300	
190/50 ZR 17 M/C (73W) TL		2450400	
190/55 ZR 17 M/C (75W) TL		2450500	

TL = Tubeless



MO TIPP (DE) - Issue: 10/2018

"Athletic all-rounder for country roads. Delivers consistent durability depending on the riding style."

PS (DE) Test Winner and Test Winner in the Wet - Issue: 06/2017

"The best handling in the wet and nearly the fastest tyre on the racetrack. The M7 RR does not know any real weakness..."



MO TIPP (DE) - Issue: 09/2017

"...the first choice for dynamic riders..."

Motorrad (DE) Test Winner in the Wet - Issue: 11/2017

PS (DE) Test Winner - Issue: 07/2016

"...the new M7 RR shows no weakness in dry or wet conditions, and it is really good on the racetrack... Our favourite "all-round" tyre of 2016"

Motorrad (DE) Test Winner - Issue: 05/2016

"...Metzeler is and remains a real all-round tyre for the sporty rider, both on the road and the track. With its balance, it stands without a doubt, in first place..."



MCN (UK) Test Winner - Issue: 03/2016

"...They offer so much confidence and safety when riding hard that I wanted to stay out and play on them after the test was finished..."

SPORTEC™ M5 INTERACT™

A great all-round Supersport tyre.

FRONT SIZE	SPECIAL VERSION	IP CODE	NOTE
17 120/70 ZR 17 M/C (58W) TL		1927400	

REAR SIZE	SPECIAL VERSION	IP CODE	NOTE
17 160/60 ZR 17 M/C (69W) TL		1971300	
180/55 ZR 17 M/C (73W) TL		1927600	

TL = Tubeless



Sportec™ Street

METZELER X-Ply sport tyre for sporty motorcycles with X-Ply fitments up to 400cc. For a thrilling, agile and long lasting ride

- Designed to maximize the on-road performances of sport and naked bikes delivering safe and stable wet performance
- New profiles enable a sporty behavior thanks to enhanced contact patch, riding precision and directionality

FRONT SIZE	SPECIAL VERSION	IP CODE	NOTE
17 100/80 - 17 M/C 52H TL		2715700	
110/70 - 17 M/C 54H TL		2715300	

FRONT/REAR SIZE	SPECIAL VERSION	IP CODE	NOTE
17 120/70 - 17 M/C 58S TL		2761600	
70/90 - 17 M/C 38S TL		2903700	
80/90 - 17 M/C 44S TL		2903800	
90/80 - 17 M/C 46S TL		2903900	

REAR SIZE	SPECIAL VERSION	IP CODE	NOTE
17 130/70 - 17 M/C 62H TL		2715400	
140/70 - 17 M/C 66H TL		2715500	
150/60 - 17 M/C 66H TL		2715800	

TL = Tubeless



SPORT TOURING



MOTORCYCLE

	SUPERBIKE & SUPERSPORT	NAKED	SUPERMOTO	SPORT TOURER	CLASSIC & SCRAMBLER	ADVENTURE
TYRE SEGMENTATION						
SPORT TOURING	ROADTEC™ 01 & ROADTEC™ 01 SE					
	ROADTEC™ Z8 INTERACT™					
URBAN MOBILITY	LASERTEC™					
	ME22, 11, BLOCK K AND BLOCK C					

THE ROADTEC™ FAMILY

Dedicated to all kinds of sport touring bikes.

- ROADTEC™ 01 SE: sport performance for naked or super sport bikes.
- ROADTEC™ 01 (HWM* and trail sizes): the sport touring tyre with reinforced carcass construction for adventure and heavy touring motorcycles.
- ROADTEC™ 01 (X-PLY sizes): the perfect all-rounder in the classic segment. ROADTEC™ 01 with X-ply structure.

ROADTEC™ 01SE



Radial sizes

ROADTEC™ 01



X-Ply sizes



Super sport, naked
and supermoto



Grand tourer
and adventure bikes



Classics and old glories

*Heavy weight motorcycle

ROADTEC™ 01SE



Ride (UK) test winner
Issue: 06/2020

MCN (UK) test winner
Issue: 08/2020

"The difference these made to the BMW was very impressive. It felt lighter, like it had better suspension and worked amazingly from cold. The biggest improvement of any tyre here"

MCN (UK)
published online 2nd March 2020

"[...] the steering is lighter than you'd expect from traditional sports touring rubber and there's more rear grip on the road than any sane person would ever need."

Moto.it (IT)
published online 31st July 2020

"Riding confidence and stability are two constants of the 01SE behaviour [...]. But maybe, the aspect that is most appreciated is that sense of linearity, neutrality, which characterises corner entry and changes in lean angles."

Motociclismo (IT)
published online 27th June 2020

"The first thing that impressed us was the light steering [...]. And then there's an excellent ability to hold the intended line."

The Sporty Side of Touring

- Complementing the range of the multiple test winner ROADTEC™ 01 with a range dedicated to sport tourers, and owners of naked and supersport motorcycles
- Improved sporty riding benefits whilst keeping the outstanding sport touring characteristics for mileage and wet conditions
- Increased grip in full lean angle thanks to a new slick shoulder
- Enhanced handling through new carcass construction

FRONT SIZE	SPECIAL VERSION	IP CODE	NOTE
17 120/70 ZR 17 M/C (58W) TL		3850800	

REAR SIZE	SPECIAL VERSION	IP CODE	NOTE
17 160/60 ZR 17 M/C (69W) TL		3850900	
180/55 ZR 17 M/C (73W) TL		3851000	
190/50 ZR 17 M/C (73W) TL		3851200	
190/55 ZR 17 M/C (75W) TL		3851300	

TL = Tubeless

TECHNICAL SPECIFICATIONS OF ROADTEC™ 01 SE

ROADTEC™ 01

ROADTEC™ 01SE

Front tyres of R01SE are multi-pitch as well as R01, improving acoustic comfort. Shortened and progressive tread grooves in the shoulder area

FRONT



REAR

Slick shoulder:

- Increased grip until the limit lean angle
- Improved safety feeling when cornering

The sport touring world has changed. Ride longer, ride farther, ride safer

The METZELER touring tyres, with a focus on enhancing grip on wet and low friction surfaces, an increased mileage and a high degree of adaptability to different motorcycles, riding styles and conditions. The contemporary answer to past and future needs. Latest update of the multiple test winner Roadtec Z8 Interact.

- Enhanced grip on wider range of tarmac/weather conditions thanks to the tread design and unique compounds
- Larger and shorter contact patch and dual compound layout increase rear tyre mileage
- METZELER patented Interact system working in conjunction with tyre structure to ensure riding stability, comfort and precision

FRONT SIZE	SPECIAL VERSION	IP CODE	NOTE
17 120/60 ZR 17 M/C (55W) TL		2669900	
120/70 ZR 17 M/C (58W) TL	(E)	3803500	
120/70 ZR 17 M/C (58W) TL	HWM	2681200	
19 110/80 R 19 M/C 59V TL		2670000	
120/70 ZR 19 M/C 60W TL		2670100	

REAR SIZE	SPECIAL VERSION	IP CODE	NOTE
17 150/70 R 17 M/C 69V TL		2670600	
160/70 ZR 17 M/C 73W TL		4016900	NEW
170/60 ZR 17 M/C 72W TL		2670700	
180/55 ZR 17 M/C (73W) TL	(E)	3562700	
180/55 ZR 17 M/C (73W) TL	HWM	2681300	
190/50 ZR 17 M/C (73W) TL	HWM	2681400	
190/55 ZR 17 M/C (75W) TL	HWM	2681500	

TL = Tubeless
HWM = Heavy Weight Motorcycles

X-Ply

FRONT SIZE	SPECIAL VERSION	IP CODE	NOTE
16 100/90 - 16 M/C 54H TL		3240900	
110/90 - 16 M/C 59V TL		3241000	
130/90 - 16 M/C 67H TL		3555200	
17 100/80 - 17 M/C 52H TL		3241100	
110/70 - 17 M/C 54H TL		3132400	
110/80 - 17 M/C 57H TL		3241200	
18 80/100 - 18 M/C 47P TL		3775900	NEW
100/90 - 18 M/C 56H TL		3241400	
100/90 - 18 M/C 56V TL		3241500	
19 90/90 - 19 M/C 52H TL		3627800	
100/90 - 19 M/C 57V TL		3132500	
3.25 - 19 M/C 54H TL		3241700	
3.25 - 19 M/C 54V TL		3242700	

REAR SIZE	SPECIAL VERSION	IP CODE	NOTE
16 130/90 - 16 M/C 67V TL		3241800	
150/80 - 16 M/C 71H TL		3555300	
17 130/70 - 17 M/C 62H TL		3132600	
130/80 - 17 M/C 65H TL		3241900	
140/70 - 17 M/C 66H TL		3242100	
140/80 - 17 M/C 69V TL		3242200	
150/70 - 17 M/C 69H TL		3242300	
150/70 - 17 M/C 69V TL		3242400	
18 90/90 - 18 M/C 51P TL		3776000	NEW
110/90 - 18 M/C 61H TL		3242500	
120/80 - 18 M/C 62H TL		3242600	
4.00 - 18 M/C 64V TL		3242800	

TL = Tubeless



Ride Magazine Wet Weather Tyres (UK)
Issue: 04/2018

"They generate an even greater feeling of grip and security."

"These tyres instantly give a refined feel to the ride like the bike feel push – likes it's been fitted with posh suspension."

"These tyres give the ability to get on the throttle earlier when exiting corners and steer with precision and confidence."



MO Tipp (DE) - Issue: 10/2018

"The perfect tyre for all-year riders and bad weather conditions. Great handling and a high mileage."

MCN (UK) - 'Tyre of the year' award 2017

Chief Road Tester Michael Neeves from Motorcycle News explained the reasons why the METZELER ROADTEC™ 01 won the

award for the second consecutive year: "The METZELER ROADTEC™ 01 has moved the game on a notch. They warm up exceptionally fast, even in the coldest conditions and offer good grip no matter the weather. They're almost perfect."



Motorrad (DE) Test Winner in the Wet
Issue: 12/2017



Motorrad&Reisen (DE)
Test Touring Tyres - Issue: 78/2017
Very good tyre

Motorrad (DE) Test Winner - Issue: 06/2016

"... in the Touring category the new Metzeler Roadtec 01 is leading: a sporty and agile road tyre which provides extreme back up grip in the wet ..."

ROADTEC™ Z8 INTERACT™



Motorrad (DE) Z8 Interact "M" Test for
Yamaha MT-07 Recommendation

Issue: 14/2017 TIPP

Motorrad (DE) Testwinner - Issue: 12/2015

"The Metzeler mixture makes it possible. Top performance on country roads, combined with class riding characteristics in the rain and crowned by the least wear in the test. That's what winners look like."

**Excellence on wet roads.
Water won't catch you unprepared**

- A long-time test winner until the breakthrough of ROADTEC™ 01, it provides a sublime blend of precise and effortless handling
- INTERACT™ Technology with three zone steel string tension layout that enhances ride enjoyment: High Mileage and Safety Feeling when cornering
- Dual compound on rear (M) and (O) special version, with five zone steel string tension layout provide the best wet performance in the Sport Touring segment
- Riding easiness, Predictability, Neutrality in maneuvers
- CMT (contour Modeling Technology) delivers more intuitive and effective handling characteristics
- π shaped tread pattern design provides improved water drainage, safety on wet and modern look

FRONT SIZE	SPECIAL VERSION	IP CODE	NOTE
17 110/70 ZR 17 M/C 54W TL	(M)	2491300	
120/60 ZR 17 M/C (55W) TL	(M)	2491200	
120/70 ZR 17 M/C (58W) TL	(M)	2283600	
18 110/80 ZR 18 M/C (58W) TL	(M)	2491500	
120/70 ZR 18 M/C (59W) TL	(M)	2491400	

REAR SIZE	SPECIAL VERSION	IP CODE	NOTE
17 150/70 ZR 17 M/C (69W) TL	(M)	2491700	
160/60 ZR 17 M/C (69W) TL	(M)	2491600	
170/60 ZR 17 M/C (72W) TL	(M)	2491900	
180/55 ZR 17 M/C (73W) TL	(M)	2283700	
180/55 ZR 17 M/C (73W) TL	(O)	2283800	
180/55 ZR 17 M/C (73W) TL	(K)	2426800	
190/50 ZR 17 M/C (73W) TL	(M)	2283900	
190/50 ZR 17 M/C (73W) TL	(O)	2284000	
190/55 ZR 17 M/C (75W) TL	(M)	2284100	
190/55 ZR 17 M/C (75W) TL	(O)	2284200	
18 140/70 ZR 18 M/C (67W) TL	(M)	2415800	
160/60 ZR 18 M/C (70W) TL	(M)	2491800	

TL = Tubeless

SPECIAL VERSION

Front E 120/70 ZR 17 M/C (58W) TL 2126600. Different tyre profile developed for enhanced handling. **Honda** Integra NC700, NC700S, NC700X.

Rear C 180/55 ZR 17 M/C (73W) TL 2008500. 2 plies Rayon for improved stability. **Yamaha** FJR 1300 **BMW** R1200 R/RT.

Rear K 180/55 ZR 17 M/C (73W) TL 2426800. Stiffer Construction for improved stability. **BMW** K1300 GT.

Rear C 190/55 ZR 17 M/C (75W) TL 2058200. 2 plies Rayon for improved stability. **BMW** K 1600 GT/GTL.

ROADTEC™ Z6

Sport Touring radial tyre delivering performance in all-weather conditions

The perfect all-round radial Sport Touring tyre. For value seekers, Z6 delivers valuable dry grip, wet performance, light, handling, comfort – and mileage.



FRONT SIZE	SPECIAL VERSION	IP CODE	NOTE
17 120/70 ZR 17 M/C (58W) TL		1448100	
REAR SIZE	SPECIAL VERSION	IP CODE	NOTE
17 160/60 ZR 17 M/C (69W) TL		1448700	
170/60 ZR 17 M/C (72W) TL		1449100	
180/55 ZR 17 M/C (73W) TL		1448600	
190/50 ZR 17 M/C (73W) TL		1449000	
18 160/60 ZR 18 M/C (70W) TL		1448900	

TL = Tubeless

LASERTEC™

Heritage tread pattern and modern technological solutions to enhance style and performance of the motorcycle

- “Sport Touring” carcass design with lighter, more resistant Polyester fibre, giving higher comfort and improving handling
- “Classic” tread pattern design ensuring effective water dispersal for safe wet riding and wear regularity with long lasting mileage
- High-Silica compounds for outstanding grip both in dry and in wet

FRONT SIZE	SPECIAL VERSION	IP CODE	NOTE
16 120/80 VB 16 M/C (60V) TL		1531100	
17 120/70 - 17 M/C 58V TL		1531200	
18 100/90 V 18 M/C (56V) TL		1534500	
110/80 - 18 M/C 58H TL		1530500	
110/80 V 18 M/C (58V) TL		1534800	
90/90 - 18 M/C 51H TL		1531700	
19 100/90 - 19 M/C 57V TL		1530100	
110/90 - 19 M/C 62H TL		1530800	
3.25 - 19 M/C 54H TL		1531300	
3.50 - 19 M/C 57H TL		1531500	
21 90/90 - 21 M/C 54H TL		1531800	

REAR SIZE	SPECIAL VERSION	IP CODE	NOTE
15 130/90 - 15 M/C 66S TL		1806700	
16 150/80 VB 16 M/C (71V) TL		1533400	
17 150/70 - 17 M/C 69H TL		1533500	
150/70 VB 17 M/C (69V) TL		1533700	
160/70 B 17 M/C 73V TL		1533800	
18 110/90 - 18 M/C 61H TL		1531900	
120/80 - 18 M/C 62H TL		1532000	
130/70 - 18 M/C 63H TL		1533000	
130/80 V 18 M/C (66V) TL		1533100	
4.00 - 18 M/C 64V TL		1533900	

TL = Tubeless





ME 22™

A renowned classic tread pattern dedicated to medium-small capacity motorcycles, thanks to an unique groove geometry for great water drainage, high mileage and consistent performance.

FRONT SIZE	SPECIAL VERSION	IP CODE	NOTE
17 60/100 - 17 M/C 33L		1713400	

FRONT/REAR SIZE	SPECIAL VERSION	IP CODE	NOTE
17 2.50 - 17 M/C 43P Reinf		2704400	
2.75 - 17 M/C 47P Reinf		2704500	
3.00 - 17 M/C 50P Reinf		0116100	
18 2.75 - 18 M/C 48P TL Reinf		1546300	
3.00 - 18 M/C 52P TL Reinf		3609800	
3.25 - 18 59P Reinf		0113700	
3.50 - 18 M/C 62P TT Reinf		3609900	
90/90 - 18 M/C 57P Reinf		2423800	

TL = Tubeless

PERFECT ME 11™

FRONT SIZE	SPECIAL VERSION	IP CODE	NOTE
18 3.25 - 18 52H		0111700	
19 3.00 - 19 49S		0747200	
3.25 - 19 54S TL		0111100	

TL = Tubeless

BLOCK™ K

FRONT/REAR SIZE	SPECIAL VERSION	IP CODE	NOTE
18 4.00 - 18 64P	Sidecar	0109700	

TL = Tubeless

BLOCK™ C

FRONT/REAR SIZE	SPECIAL VERSION	IP CODE	NOTE
16 2.50 - 16 41P Reinf		1419400	
2.75 - 16 46P Reinf		0109200	
3.25 - 16 55P Reinf		0109500	
3.50 - 16 58P Reinf		0109600	
18 3.25 - 18 M/C 52S		0712800	
3.50 - 18 56S		0932300	
4.00 - 18 64H (C) TOURING SPEC		0110100	
19 3.00 - 19 54P Reinf		0109800	
3.25 - 19 54P		0109900	
3.50 - 19 57P		0110000	



TL = Tubeless



CRUISING



CRUISERS AND TOURERS

	Cruisers 	Tourers & contemporary customizations 	Vintage customizations 
PERFORMANCE	CRUISETEC™		
TOURING		ME 888 MARATHON™ ULTRA	
			PERFECT ME 77™

Product	Target Motorcycles	Main benefits
CRUISETEC™	Cruisers	Top handling, Dry and wet grip, easy line taking and holding, performance consistency, effortless riding, safety.
ME 888 Marathon™	All typologies of American-styled cruisers and tourers, customised versions	Mileage, Comfort, Wet Grip, range width for customizations
ME 888 Marathon™ White Wall		+ White Wall for Classic style look
ME 888 Marathon™ Orange Wall		+ Orange Wall for Custom style look
ME 77 PERFECT	Old-styled cruisers, styled-bobber customized machines	Vintage look

PERFECT ME 77™



From METZELER legacy, Tyre Technology for devotees of vintage customizations

- Tyre contour with wide curvature for easy handling and precise cornering
- Geometric art tread design with center longitudinal groove and thick sidewall for a unique vintage look, efficient water drainage and high mileage
- Proven grip and high slip resistance on wet and dry road

FRONT SIZE	SPECIAL VERSION	IP CODE	NOTE
16 110/90 - 16 M/C 59S		1016500	
	130/90 - 16 M/C 67H TL	3139700	
18 3.50 - 18 56S TL		0130400	
	90/100 - 18 M/C 54S	1253000	
19 3.50 - 19 57S TL		0130900	
21 90/90 - 21 M/C 54H TL		3139600	

FRONT/REAR SIZE	SPECIAL VERSION	IP CODE	NOTE
18 3.00 - 18 M/C 47S TL		1204700	

REAR SIZE	SPECIAL VERSION	IP CODE	NOTE
15 130/90 - 15 M/C 66S TL		1268200	
	140/90 - 15 M/C 70S	0747300	
16 110/90 - 16 M/C 59S TL	120/90 - 16 M/C 63H TL	0133100	
	130/90 - 16 M/C 67S TL	0129900	
	130/90 B 16 M/C 73H TL Reinf	3139800	
	150/80 B 16 M/C 77H TL Reinf	3139900	
	4.60 - 16 59S TL	0131000	
18 110/90 - 18 M/C 61S	3.50 - 18 56S	1253100	
	4.00 - 18 64H TL	0130500	
	4.00 - 18 64H TL	0131800	
	4.10 - 18 60H TL	0132000	

TL = Tubeless

CRUISETEC™

Performance Perfected

The ultimate V-Twin tyre to perfect the performance of yesterday's, today's and tomorrow's V-Twins

- Enjoy performance-cruising also in wet conditions
- A consistent performance
- Smooth and effortless riding
- Enhanced confidence and safety
- Dual-Compound layout on rears and performance-oriented contour



FRONT SIZE	SPECIAL VERSION	IP CODE	NOTE
16 MT90 B 16 M/C 72H TL		3578000	
130/90 B 16 M/C 73H TL Reinf		3576400	
150/80 - 16 M/C 71H TL		3576900	
17 130/80 B 17 M/C 65H TL		3576100	
130/80 B 17 M/C 65H TL	(I)	3950900	
18 130/70 B 18 M/C 63H TL		3974500	NEW
130/70 R 18 M/C 63H TL		3578400	NEW
160/60 R 18 M/C 70V TL		3797200	
19 100/90 - 19 M/C 57H TL		3576600	
110/90 - 19 M/C 62H TL		3577600	
120/70 ZR 19 M/C (60W) TL		3577300	
130/60 B 19 M/C 61H TL		3576300	
130/60 B 19 M/C 66H TL Reinf		3773300	
21 MH90 - 21 M/C 54H TL		3577800	
120/70 B 21 M/C 68H TL Reinf		3577200	
130/60 B 21 M/C 63H TL		3797300	

REAR SIZE	SPECIAL VERSION	IP CODE	NOTE
16 MU85 B 16 M/C 77H TL		3578100	
MT90 B 16 M/C 74H TL		3578300	
130/90 B 16 M/C 73H TL Reinf		3576800	
150/80 B 16 M/C 77H TL Reinf		3576500	
180/60 R 16 M/C 80H TL Reinf		3577700	
180/60 R 16 M/C 80H TL Reinf	(I)	3838700	
180/65 B 16 M/C 81H TL Reinf		3576200	
180/70 B 16 M/C 77H TL		3577000	
200/55 R 16 M/C 77H TL Reinf		3578500	
17 160/70 B 17 M/C 79V TL Reinf		3576700	
200/55 R 17 M/C 78V TL		3577900	
18 150/70 B 18 M/C 76H TL Reinf		3578200	
180/55 B 18 M/C 80H TL Reinf		3577100	
180/55 ZR 18 M/C (74W) TL		3577500	
240/40 VR 18 M/C (79V) TL		3577400	
260/40 VR 18 M/C (84V) TL		3656900	

TL = Tubeless



ME 888 MARATHON™ ULTRA

Ultra mileage, Metzeler performance



- Ultra high mileage coupled with Metzeler performance and handling also on wet
- Specifically designed for big tourers, V-Twin cruisers and their customizations
- Technology offering consistent performance throughout the tyre's life
- Outstanding smooth handling
- Ultra-wide range including radial and bias belted tyres, XXL fronts and rears, fronts up to 26 inches, whitewalls and orangewalls for an incomparable customization style

FRONT SIZE	SPECIAL VERSION	IP CODE	NOTE
16 130/90 - 16 M/C 67H TL		2318000	
130/90 - 16 M/C 67H TL	WHITEWALL	2407600	
130/90 B 16 M/C 73H TL Reinf		2703600	
150/80 - 16 M/C 71H TL		2661600	
150/80 R 16 M/C 71V TL		2680600	
MT90 B 16 M/C 72H TL		2318100	
MT90 B 16 M/C 72H TL	WHITEWALL	2407500	
17 120/70 B 17 M/C 58V TL		2703200	
120/90 - 17 M/C 64S TT		3133100	
130/70 R 17 M/C 62V TL		3133200	
130/80 B 17 M/C 65H TL		2318200	
130/80 B 17 M/C 65H TL	WHITEWALL	2407700	
140/75 R 17 M/C 67V TL		3133300	
140/80 - 17 M/C 69H TL		2703500	
150/80 R 17 M/C 72V TL		2680800	
18 100/90 - 18 M/C 56H TL		2703700	
110/90 - 18 M/C 61H TL		2703800	
120/70 ZR 18 M/C (59W) TL		3133600	
130/60 VR 18 M/C (60V) TL		3133800	
130/70 B 18 M/C 63H TL		2531500	
130/70 R 18 M/C 63H TL		2429400	
130/70 R 18 M/C 63V TL		3133900	NEW
140/70 B 18 M/C 73H TL Reinf		3134000	
19 100/90 - 19 M/C 57H TL		3745700	
100/90 - 19 M/C 57H TL	WHITEWALL	2407800	
100/90 - 19 M/C 57H TL	ORANGEWALL	3483600	
110/90 - 19 M/C 62H TL		2661500	
120/70 ZR 19 M/C (60W) TL		2680700	
130/60 B 19 M/C 61H TL		2634800	
21 80/90 - 21 M/C 48H TL		2703000	
90/90 - 21 M/C 54H TL		2616400	
120/70 B 21 M/C 68H TL Reinf		2661700	
120/70 B 21 M/C 68H TL Reinf	WHITEWALL	2718100	
120/70 - 21 M/C 62V TL		3134100	
130/60 - 21 M/C 63H TL		3272400	
MH90 - 21 M/C 54H TL		2408600	
MH90 - 21 M/C 54H TL	WHITEWALL	2408500	
23 130/60 B 23 M/C 65H TL		2429300	

TL = Tubeless





REAR SIZE	SPECIAL VERSION	IP CODE	NOTE
15 140/90 B 15 M/C 70H TL		2408700	
150/90 B 15 M/C 80H TL Reinf		2616500	
160/80 - 15 M/C 74S		3134400	
170/80 B 15 M/C 77H TL		2318400	
170/80 B 15 M/C 77H TL	WHITEWALL	2407900	
180/70 B 15 M/C 76H TL		2703100	
200/70 B 15 M/C 82H TL		3134500	
16 130/90 B 16 M/C 73H TL Reinf		2318500	
130/90 B 16 M/C 73H TL Reinf	WHITEWALL	2408300	
140/90 B 16 M/C 77H TL Reinf		2408800	
140/90 B 16 M/C 77H TL Reinf	WHITEWALL	2408900	
150/80 B 16 M/C 77H TL Reinf		2318600	
150/80 B 16 M/C 77H TL Reinf	WHITEWALL	2408000	
150/80 B 16 M/C 77H TL Reinf	ORANGEWALL	3483700	ORANGE WALL
160/80 B 16 M/C 75H TL		2616600	
170/70 B 16 M/C 75H TL		2531600	
180/60 R 16 M/C 74H TL		2429500	
180/60 R 16 M/C 80H TL Reinf		2634900	
180/65 B 16 M/C 81H TL Reinf		2318700	
180/65 B 16 M/C 81H TL Reinf	WHITEWALL	2408400	
180/70 R 16 M/C 77V TL		2680900	
240/50 R 16 M/C 84V TL		2681100	
MT90 B 16 M/C 74H TL		2318800	
MT90 B 16 M/C 74H TL	WHITEWALL	2408200	
MU85 B 16 M/C 77H TL		2318900	
MU85 B 16 M/C 77H TL	WHITEWALL	2408100	
200/60 R 16 M/C 79V TL		2704000	
17 140/80 B 17 M/C 69V TL		3134600	
170/60 R 17 M/C 78V TL Reinf		3134700	
160/70 B 17 M/C 79V TL Reinf		2409000	
180/60 B 17 M/C 75V TL		2703300	
200/50 ZR 17 M/C 75W TL		2681000	
200/55 R 17 M/C 78V TL		2703900	
210/50 ZR 17 M/C (78W) TL		3134800	
18 150/70 B 18 M/C 76H TL Reinf		2616700	
160/60 R 18 M/C 76V TL Reinf		3134900	
180/55 ZR 18 M/C (74W) TL		2704200	
180/55 B 18 M/C 80H TL Reinf		2634700	
200/50 R 18 M/C 82H TL Reinf		2703400	
210/40 R 18 M/C 73H TL		3135100	
240/40 VR 18 M/C (79V) TL		2704100	
280/35 VR 18 M/C (84V) TL		3135200	
300/35 VR 18 M/C (87V) TL		3135300	
260/40 VR 18 M/C (84V) TL		2781500	

TL = Tubeless



ENDURO STREET



THE ENDURO STREET FAMILY

Dedicated to all kinds of big enduro, trail and adventure bikes.

- TOURANCE™ NEXT 2
- TOURANCE™
- Enduro 1 and 2

TOURANCE™ NEXT 2

NEW



TOURANCE™



ENDURO 1 ENDURO 2



The evolution of the legendary TOURANCE™ NEXT, a newest road-oriented benchmark for riding pleasure that dares you to challenge any road.

The legendary road-oriented tyre for dual purpose motorcycles.

All-round dual purpose tyres with a Terrain/Tarmac Soul.

Dedicated to the latest evolution of adventure motorcycles

For contemporary and vintage dual-purpose motorcycles

Dedicated to vintage off-road/on-road glories

TOURANCE™ NEXT 2



The evolution of the legendary TOURANCE™ NEXT, a newest road-oriented benchmark for riding pleasure that dares you to challenge any road.

- Agile and neutral behaviour leading accurate control feeling and solid all-grades handling
- Sets a new benchmark for wet and braking performance. 1,5m shorter stopping distance at 85km/h in the wet thanks also to METZELER HYPERBASE compound layout.
- Immediate and durable performance, throughout the entire tyre life-cycle thanks to new compounds and DYMATEC technology
- Outstanding comfort and safety whilst riding with or without pillions or luggage

FRONT SIZE	SPECIAL VERSION	IP CODE	NOTE
19 110/80 R 19 M/C 59V TL		3960600	NEW
120/70 R 19 M/C 60V TL		3960400	NEW
120/70 ZR 19 M/C 60W TL		3960700	NEW
21 90/90 - 21 M/C 54V TL		3961200	NEW

REAR SIZE	SPECIAL VERSION	IP CODE	NOTE
17 150/70 R 17 M/C 69V TL		3961500	NEW
170/60 R 17 M/C 72V TL		3960500	NEW
170/60 ZR 17 M/C 72W TL		3960800	NEW
18 150/70 R 18 M/C 70V TL		3961400	NEW

TL = Tubeless



* Than the best competitor tested in the same tyre segment, according to internal wet braking test methodology on BMW R1250GS with $V_{In} = 85\text{km/h}$, $V_{Out} = 0\text{km/h}$, $T_{Ambient} = 25^{\circ}\text{C}$, $T_{Road} = 25^{\circ}\text{C}$

NEW SIZES

TOURANCE™

The knobby tyre for dual purpose motorcycles

- Carcass structures designed for enhanced straight line stability at high speed with smooth rolling characteristics for long distance journeys
- Maximum mileage on the street and great traction also on light off-road surfaces thanks to tread layout and compound
- Great grip with light and precise handling make riding easier in all weather conditions

FRONT SIZE	SPECIAL VERSION	IP CODE	NOTE
14 110/80 - 14 M/C 53P DP TL		3849100	NEW
19 100/90 - 19 M/C 57H TL	(K)	3907100	
100/90 - 19 M/C 57H TL		3773000	
100/90 - 19 M/C 57S TT		3908100	
110/80 - 19 M/C 59H DP TL		3967200	
110/80 - 19 M/C 59H TL		3079800	
110/80 R 19 M/C 59V TL		2315900	
21 80/90 - 21 M/C 48S		2059200	
90/90 - 21 M/C 54H TL		3078600	
90/90 - 21 M/C 54S		3555600	

REAR SIZE	SPECIAL VERSION	IP CODE	NOTE
13 130/70 - 13 M/C 57P DP TL		3849200	NEW
17 120/90 - 17 M/C 64S		1012200	
130/80 - 17 M/C 65S DP TT		3966800	
130/80 R 17 M/C 65S TL		1086800	
140/80 R 17 M/C 69H TL		1012100	
150/70 R 17 M/C 69H TL		3079900	
150/70 R 17 M/C 69V TL		1127900	
170/60 R 17 M/C 72V TL		2763500	
18 120/80 - 18 M/C 62S DP TT		3966600	NEW

TL = Tubeless

SPECIAL VERSION

Rear R 150/70 R 17 M/C 69H TL 2684100: dedicated version. **BMW G 310 GS**

ENDURO 1, ENDURO 2

All-round dual purpose tyre dedicated to on-road riding and light off-road for a wide usage range

- The Legendary genuine fitment of several BMW G/S airheads (both monolever and Paralever) since 1980
- Tread Pattern design with optimized blocks distribution for smooth running performance
- Compound tuned specifically for high mileage
- Reliable slip resistance on the road, good power transfer on different surfaces.

ENDURO 1

FRONT SIZE	SPECIAL VERSION	IP CODE	NOTE
21 3.00 - 21 51R		0139400	

ENDURO 2

REAR SIZE	SPECIAL VERSION	IP CODE	NOTE
18 4.00 - 18 64R		0139200	



ENDURO ON/OFF



THE KAROO™ FAMILY

Metzeler for Enduro on/off

Dedicated to all kinds of cross-country riding on large capacity adventure bikes.
 The KAROO™ family consists of three different products:
 KAROO™ Street, a unique combination of scrambler look and feel with on-road agility
 KAROO™ 3, dedicated to raids and adventure journeys
 KAROO™ Extreme, a product developed to compete in professional Rally races



KAROO™
Street

KAROO™ 3

KAROO™
Extreme



EXPEDITION



ADVENTURE



RALLY

KAROO™ Street



Motorrad & Reisen (DE)
Issue: 88/2018

Very good tyre

"The Metzeler Karoo Street manages the balancing act between outstanding street and off-road performance. While other tyres fail due to the mixture of conditions, the Karoo Street manages to stay stable."

The off-road tyre with on-road performance

- Outstanding on-road performances on a knobby tread pattern
- High Silica compound to achieve a high level of grip on road, both in dry and wet conditions
- Excellent traction on dirt, with on-road agility
- Maintaining top cornering precision and stability throughout the tyre's life
- Constant contact patch enables good integration with electronic rider aids

FRONT SIZE	SPECIAL VERSION	IP CODE	NOTE
17 110/70 - 17 M/C 54S M+S TL		3778000	NEW
	120/70 R 17 M/C 58V M+S TL	3555800	
19 100/90 - 19 M/C 57V M+S TL		3555700	
	110/80 R 19 M/C 59V M+S TL	3142500	
120/70 R 19 M/C 60V M+S TL		3142600	
	21 90/90 - 21 M/C 54V M+S TL	3142700	
90/90 - 21 M/C 54H TT	3735100		
90/90 - 21 M/C 54H TL	3735300		

REAR SIZE	SPECIAL VERSION	IP CODE	NOTE
17 130/80 R 17 M/C 65V M+S TL		3556000	
	140/70 - 17 M/C 66S M+S TL	3778100	NEW
140/80 R 17 M/C 69V M+S TL	3556100		
150/70 R 17 M/C 69V M+S TL	3142800		
170/60 R 17 M/C 72V M+S TL	3142900		
180/55 R 17 M/C 73V M+S TL	3555900		
18 150/70 R 18 M/C 70V M+S TL		3143000	
	150/70 R 18 M/C 70H TT	3735200	
150/70 R 18 M/C 70H TL	3735400		

TL = Tubeless
M+S = Mud + Snow

KAROO™ 3

The best companion for your off-road adventures.
Dedicated to off-road explorers.
The official partner of 2020 BMW GS Trophy.

- Enhanced Off-Road traction and handling
- Cutting edge tread design lends to reliable on-road performances
- Extended mileage for boundless adventures
- Versatile and suitable for both light and heavy ENDURO bikes

FRONT SIZE	SPECIAL VERSION	IP CODE	NOTE
19 110/80 - 19 M/C 59R M+S TL		2316000	
	120/70 R 19 M/C 60T M+S TL	2316100	
21 90/90 - 21 M/C 54R M+S TL		2316200	
	90/90 - 21 M/C 54S M+S TL	3560300	

REAR SIZE	SPECIAL VERSION	IP CODE	NOTE
17 130/80 - 17 M/C 65R M+S TL		2316500	
	140/80 - 17 M/C 69R M+S TL	2316600	
150/70 - 17 M/C 69R M+S TL	2316300		
170/60 R 17 M/C 72T M+S TL	2316400		
18 140/80 - 18 M/C 70R M+S TL		2316700	
	150/70 - 18 M/C 70R M+S TL	2316800	

TL = Tubeless
M+S = Mud + Snow



Motorrad & Reisen (DE)
Test Enduro Adventure Tyres

Issue: 82/2017

Very good tyre

"A good compromise for on and off road riding. A solution for Enduro riders looking for a tyre to deliver mileage on the road and performance off road"

Multipurpose and racing rally off-road tyre with extreme traction and versatility

- Blocks layout and shape for massive traction in desert dunes and off-road fords
- Strength, resistance and durability for every long distance off-road application
- Extreme versatility of use on all kind of terrains including on-road transfers
- Outstanding stability on high-speed pipeline straights

FRONT SIZE	SPECIAL VERSION	IP CODE	NOTE
21 90/90 - 21 M/C 54R MST TT	Desert	3908300	NEW
90/90 - 21 M/C 54S MST TT		3908200	NEW

REAR SIZE	SPECIAL VERSION	IP CODE	NOTE
18 140/80 - 18 M/C 70R MST		2470500	
150/70 R 18 M/C 70S MST TL		3560500	NEW

MST = Multi Service Tyre



ENDURO 3 SAHARA

Enduro tyre with very good on-road performance dedicated to the globetrotters always looking for fun riding no matter what the terrain is

- Dedicated tread compound perfectly combining safe on-road cornering grip and good off-road traction
- Tread pattern geometry designed for fast self-cleaning: stable and precise trajectories without skidding also on soft, muddy terrains
- Great handling with easy corner entry, stable cornering and high safety margins when riding at the limit

FRONT SIZE	SPECIAL VERSION	IP CODE	NOTE
18 2.75 - 18 M/C 42P TT		2484600	
19 90/90 - 19 M/C 52P		1846600	
21 80/90 - 21 M/C 48S		0143500	
90/90 - 21 M/C 54H MST TL		3971400	
90/90 - 21 M/C 54S MST TT		3966200	

REAR SIZE	SPECIAL VERSION	IP CODE	NOTE
17 110/90 - 17 M/C 60P MST TT		3982800	
120/90 - 17 M/C 64S		0143600	
130/80 - 17 65T TL		0142700	
130/80 - 17 M/C 65S MST TT		3982700	
140/80 - 17 M/C 69H MST TT		3982900	
18 90/90 - 18 M/C 45P		2324000	
110/80 - 18 M/C 58S		1846800	
120/80 - 18 M/C 62S MST TT		3966700	
140/80 - 18 M/C 70S MST TT		3983000	
4.00 - 18 64S		0143000	

TL = Tubeless



ENDURO OFF ROAD/ MOTOCROSS



METZELER ENDURO OFF ROAD/ MOTOCROSS PORTFOLIO

Enduro

Cross

**Enduro F.I.M.
Compliance**

6 DAYS EXTREME

NEW SIZES

MC360 mid soft

NEW SIZES

MC360 mid hard

NEW SIZES





NEW SIZES



Ultimate ENDURO F.I.M. tyre, dominating both the ENDURO GP - 40 times Enduro World Champion up to 2020 - and Extreme ENDURO racing world, developed with factory riders for the most extreme challenges

High-resistance Polyester carcass-material with X-ply construction for superior structural characteristics and excellent puncture resistance.

- Tread block layout designed to offer tailored grip and control depending on the application
- Range includes both sizes dedicated to Enduro GP and Extreme Enduro
- Color tread lines help identifying the Extreme Enduro versions.



FRONT SIZE	SPECIAL VERSION	IP CODE	NOTE
21 90/90 - 21 M/C 54M M+S		2477600	Enduro GP - Replacement
90/90 - 21 M/C 54M M+S	Soft	4073200	NEW - Extreme Enduro - ORANGE tread lines
90/100 - 21 M/C 57R MST		3286500	
90/100 - 21 M/C 57M MST	Super Soft	4074600	NEW - Enduro Extreme - LIME tread lines

REAR SIZE	SPECIAL VERSION	IP CODE	NOTE
18 110/80 - 18 M/C 58R M+S		3841700	
120/90 - 18 M/C 65R M+S		3286600	Enduro GP Replacement
130/90 - 18 M/C 69M M+S		1907200	
140/80 - 18 M/C 70M M+S		2477700	Enduro GP - Replacement
140/80 - 18 M/C 70M M+S	Medium	4067900	NEW - Enduro GP Replacement
140/80 - 18 M/C 70M M+S	Soft	2529900	Extreme Enduro - ORANGE tread lines
140/80 - 18 M/C 70M M+S	Super Soft	3864900	Extreme Enduro - LIME tread lines

M+S = Mud + Snow
 MST = Multi Service Tyre
 NHS = Not for Highway Service



NEW SIZES**MOTOCROSS /45**

MC360™ MID SOFT

Change the ground, not the tyre.
Optimal choice for soft and midsoft terrains

- A comprehensive range dedicated to off-road racing including Motocross, Cross-country, non-F.I.M. Enduro and Freestyle
- Alternated cut knobs for progressive cornering action.
- Scoops maximise traction on soft and mid-soft terrain
- Optimal directionality and damping on whoops
- Portfolio includes both road legal and new motocross racing NHS R specifications
- Reversible tread patterns, the fun never ends!

FRONT SIZE	SPECIAL VERSION	IP CODE	NOTE
21 80/100 - 21 M/C 51M MST		2762000	
80/100 - 21 M/C 51M MST	R	4023200	NEW
90/90 - 21 M/C 54M MST		2900600	

REAR SIZE	SPECIAL VERSION	IP CODE	NOTE
120/100 - 18 M/C 68M MST		2762600	
120/80 - 18 M/C 58R MST		3822900	NEW
140/80 - 18 M/C 70M MST		2900700	
120/80 - 18 M/C 58R MST		3822900	NEW
140/80 - 18 M/C 70M MST		2900700	
120/100 - 18 M/C 68M MST		2762600	
120/80 - 18 M/C 58R MST		3822900	NEW
140/80 - 18 M/C 70M MST		2900700	
19 100/90 - 19 M/C 57M MST		2762800	
100/90 - 19 NHS 57M R	R	4023300	NEW
110/90 - 19 M/C 62M MST		2762200	
110/90 - 19 NHS 62M R	R	4023400	NEW
120/80 - 19 M/C 63M MST		2763200	
120/80 - 19 NHS 63M R	R	4023500	NEW

MST = Multi Service Tyre

**NEW SIZES**

MC360™ MID HARD

Change the ground, not the tyre.
The perfect tyre for medium and hard terrain

- A comprehensive range dedicated to off-road racing including Motocross, Cross-country, non-F.I.M. Enduro and Freestyle
- CKB (Continuous Knob Binding) improving tearing and wearing resistance of the knobs
- Larger block size to increase contact patch
- Alternated -cut-knob for outstanding durability
- Portfolio includes both road legal and new motocross racing NHS R specifications
- Reversible tread patterns, the fun never ends!

FRONT SIZE	SPECIAL VERSION	IP CODE	NOTE
21 80/100 - 21 M/C 51M MST		2762100	
90/90 - 21 M/C 54M MST		2900800	

REAR SIZE	SPECIAL VERSION	IP CODE	NOTE
18 100/100 - 18 M/C 59M MST		2763100	
110/100 - 18 M/C 64M MST		2762500	
120/100 - 18 M/C 68M MST		2762700	
140/80 - 18 M/C 70M MST		2900900	
19 100/90 - 19 M/C 57M MST		2762900	
110/90 - 19 M/C 62M MST		2762300	
120/80 - 19 M/C 63M MST		2763300	

MST = Multi Service Tyre

**METZELER** 
MOTORCYCLE TYRES

Gel



DESCRIPTION

BOX of 12 GEL Tube 60g
GEL TUB 1 Kg

IP CODE

9203300
9203500



Mousse

Mousses are rubber foam equipments which – beside preventing flat tyres during through off-road sections – feature dynamic properties capable to make faster, more efficient or simply effortless the off-road racing.

METZELER mousses are intended to replace inner tubes in off-road tyres for both motocross and Enduro competitions; once fitted, METZELER mousses simulate an equivalent inflation pressure to 0.7bar +/-0.1, far below the pressure advised for on-road use.

Particular attention must be then paid to suspension settings when racing with mousses.

METZELER mousse are marked NHS, which means they must not be used on public roads.

When fitting a mousse, the mounting lubricant gel must be spread completely inside the tyre, avoiding the beads.

METZELER mousse are available in 18", 19" and 21" fitments, and must be fitted using METZELER mousse gel.

How to read METZELER mousse specifications

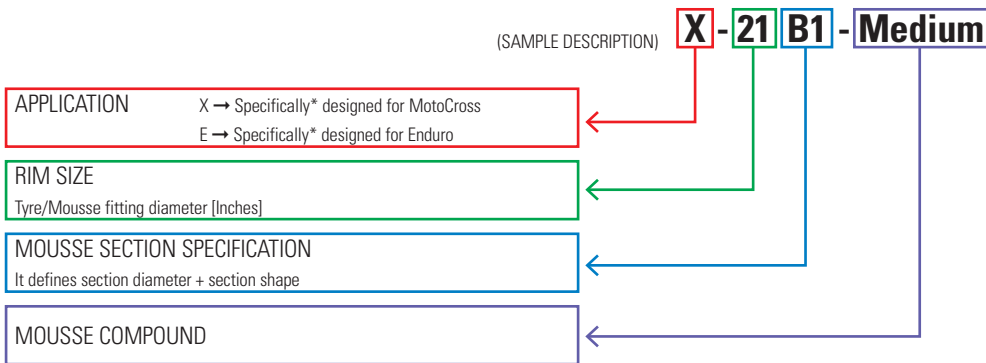

*but not exclusively

FRONT SIZE	SPECIAL VERSION	IP CODE	NOTE
21 MOUSSE E-21C1-Medium		9252800	90/90
MOUSSE E-21C2-Medium		9253000	90/100
MOUSSE X-21B1-Medium		9252700	80/100

REAR SIZE	SPECIAL VERSION	IP CODE	NOTE
18 MOUSSE E-18F1-Medium		9253100	120/90
MOUSSE E-18H1-Medium		9253300	140/80-18
MOUSSE E-18H1-Soft		9253200	140/80-18 FLAT
MOUSSE E-18H1-Super Soft		9338100	140/80-18 ss NEW
19 MOUSSE X-19D1-Medium		9253500	100/90
MOUSSE X-19E1-Medium		9253600	110/90
MOUSSE X-19F1-Medium		9253700	120/90

MST = Multi Service Tyre



SCOOTER



METZELER PERFORMANCE SCOOTER PORTFOLIO

ROADTEC™ SCOOTER

FEELFREE™

SPORTEC™ STREET

The scooter specialist: turn bad weather into good times

- The new development for all kind of scooters (ranging from 10 to 16 inches wheel)
- ROADTEC™ 01 derived tread pattern design, now featuring sipes for more grip in all conditions, especially on wet and low friction surfaces
- Extreme flexibility and versatility on the broadest range of weather, temperature and road-surface conditions
- High Silica content for greater grip on wet and wider temperature range of application



FRONT SIZE	SPECIAL VERSION	IP CODE	NOTE
12 110/90 - 12 64P TL		3845300	NEW
13 110/70 - 13 M/C 48P TL		3776700	
110/90 - 13 M/C 56P TL		3845800	
130/60 - 13 M/C 53P TL		3846000	
14 90/80 - 14 M/C 49S TL Reinf		3987000	
90/90 - 14 M/C 46P TL		3846200	
110/80 - 14 M/C 59S TL Reinf		3995200	NEW
15 120/70 - 15 M/C 56S TL		3517900	
16 100/80 - 16 M/C 50P TL		3000000	
110/70 - 16 M/C 52P TL		3846400	
110/70 - 16 M/C 52S TL		3120200	

FRONT/REAR SIZE	SPECIAL VERSION	IP CODE	NOTE
10 3.00 - 10 50J TL Reinf		3844300	
90/90 - 10 50J TL		3844400	
100/80 - 10 53L TL		3844500	
100/90 - 10 61J TL Reinf		3844600	
120/90 - 10 66L TL		3844800	NEW
130/70 - 10 59L TL Reinf		3844900	NEW
130/90 - 10 61L TL		3845000	NEW
11 130/70 - 11 60L TL Reinf		3845100	NEW
12 110/70 - 12 47P TL		3995300	NEW
120/70 - 12 51P TL		3845400	
130/70 - 12 62L TL Reinf		3845500	
140/70 - 12 60L TL		3845700	
13 120/70 - 13 M/C 53L TL		3845900	NEW
140/60 - 13 M/C 57L TL		3846100	
14 100/80 - 14 M/C 54S TL Reinf		3987100	
120/70 - 14 M/C 55S TL		3846300	
120/80 - 14 M/C 58S TL		3556800	

REAR SIZE	SPECIAL VERSION	IP CODE	NOTE
12 130/70 - 12 62P TL Reinf		3845600	
140/70 - 12 65P TL Reinf		3846500	
13 130/60 - 13 M/C 60P TL Reinf		4017300	NEW
130/70 - 13 M/C 63P TL Reinf		3846600	NEW
150/70 - 13 M/C 64S TL		3556900	
14 100/90 - 14 M/C 57P TL Reinf		3846700	
140/60 - 14 M/C 64P TL Reinf		3846800	NEW
140/70 - 14 M/C 68P TL Reinf		3846900	
150/70 - 14 M/C 66S TL		3518000	
16 120/80 - 16 M/C 60P TL		3000100	
130/70 - 16 M/C 61S TL		3847000	
130/70 R 16 M/C 61S TL		3974400	
130/80 - 16 M/C 64P TL		3847100	NEW
140/70 - 16 M/C 65P TL		3847200	NEW

TL = Tubeless

FEELFREE™



Renowned equipment for a high performance scooters

- METZELER wet performance thanks to a wide contact area and high-silica compounds
- Profile optimized for high-speed stability and handling meets a tread pattern design for sport-touring tyres
- A premium genuine fitment of multiple hi-performance scooters by high-end manufacturers.

Radial

FRONT SIZE	SPECIAL VERSION	IP CODE	NOTE
12 110/90 - 12 64P TL		1660000	
14 80/80 - 14 M/C 43P TL Reinf		2626800	
120/70 R 14 M/C 55H TL		1816600	
15 120/70 R 15 M/C 56H TL		1816700	
16 110/70 - 16 M/C 52S TL		1677800	

REAR SIZE	SPECIAL VERSION	IP CODE	NOTE
14 160/60 R 14 M/C 65H TL		1816900	
15 160/60 R 15 M/C 67H TL		1816800	
16 130/70 R 16 M/C 61S TL		1922100	
130/80 - 16 M/C 64P TL		1659900	

TL = Tubeless



A X-Ply spory range for thrilling, agile and long lasting scooter riding

- Sporty profiles enable dynamic and precise trajectories
- Durability and wear uniformity
- Designed to maximise the on-road performance providing safe and stable wet performance.



FRONT SIZE	SPECIAL VERSION	IP CODE	NOTE
14 70/90 - 14 M/C 34S TL		2716100	
80/90 - 14 M/C 40S TL		2716000	
90/80 - 14 M/C 49S TL Reinf		2761900	
90/90 - 14 M/C 46S TL		2716200	

FRONT/REAR SIZE	SPECIAL VERSION	IP CODE	NOTE
14 80/80 - 14 M/C 43S TL Reinf		2761700	

REAR SIZE	SPECIAL VERSION	IP CODE	NOTE
14 80/90 - 14 M/C 40S TL		2715900	
90/80 - 14 M/C 49S TL Reinf		2761800	
90/90 - 14 M/C 46S TL		2716300	
100/80 - 14 M/C 48S TL		2716400	
100/90 - 14 M/C 57P TL Reinf		2919400	
110/80 - 14 M/C 59S TL Reinf		2716500	

TL = Tubeless

Valve description

Following valve types are used among the Metzeler tubes range.
Find the corresponding dimensional description of each valve type.

V1-07-1

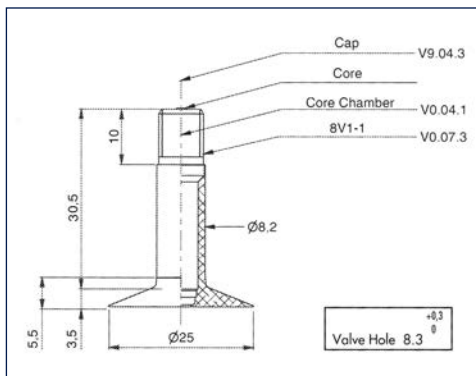
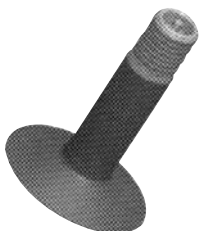

V1-08-1

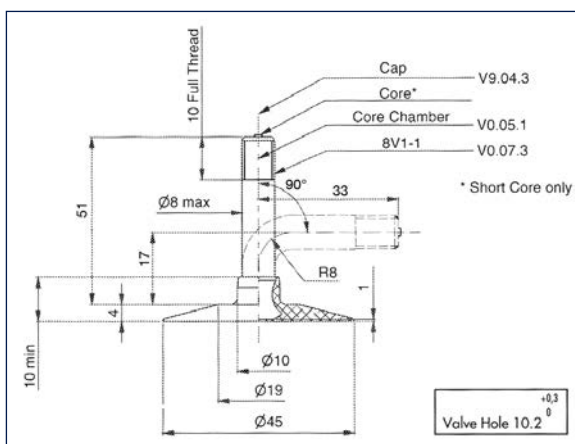

Normen				
Europa ETRTO	D DIN	USA TRA	Biege-winkel	Position
V1-07-1	-	TR1		
V1-08-1	33G/90°	*TR87	90	SV
V1-09-1	34G	TR4		
V1-09-1	34G	TR4		SV
V6-02-1	41.5G/70°	-	70	SV

SV = Seitenventil

V1-09-1

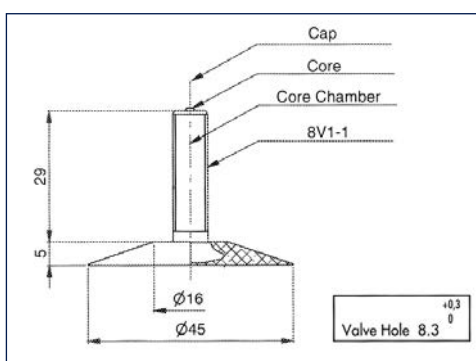

V6-02-1

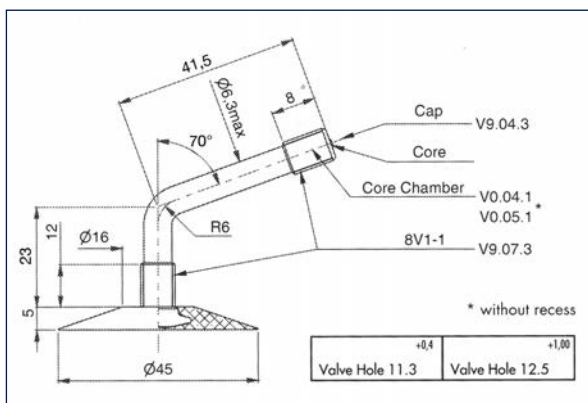
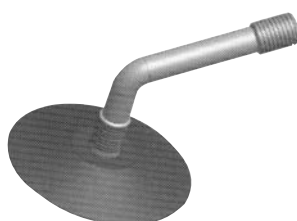

TUBE AND VALVE FITMENT CHART/53

	Tyre size	IP code	Description		Thickness (mm)	Valve DIN	Valve ETRTO	Valve TRA	Valve Bend	Valve position	
10"	3.00 - 10	2598810	ME-D10 M/C	Tube ME Valve V1-09-1	1,40	34G	V1-09-1	TR4		SV	
	3.50 - 10	2598810	ME-D10 M/C	Tube ME Valve V1-09-1	1,40	34G	V1-09-1	TR4		SV	
	100/80 - 10	2598810	ME-D10/1 M/C	Tube ME Valve V1-09-1	1,40	34G	V1-09-1	TR4		SV	
	110/80 - 10	2598810	ME-D10 M/C	Tube ME Valve V1-09-1	1,40	34G	V1-09-1	TR4		SV	
	90/90 - 10	2598810	ME-D10 M/C	Tube ME Valve V1-09-1	1,40	34G	V1-09-1	TR4		SV	
15"	160/70 - 15	2597310	ME-F16 M/C	Tube ME Valve 34G SV	1,40	34G	V1-09-1	TR4		SV	
	180/70 - 15	2597510	ME-G15 M/C	Tube ME Valve V6-02-2	1,90	41,5G/86	V6-02-2	-			
	180/70 - 15	2597610	ME-H1 15 M/C	Tube ME Valve V1-09-1 SV	1,90	34G	V1-09-1	TR4		SV	
	180/70-15	2597710	ME-15 M/C		1,9	34G	V1-09-1	TR4			
	200/70 - 15	2597510	ME-G15 M/C	Tube ME Valve V6-02-2	1,90	41,5G/86	V6-02-2	-			
	200/70 - 15	2597610	ME-H1 15 M/C	Tube ME Valve V1-09-1 SV	1,90	34G	V1-09-1	TR4		SV	
	140/80 - 15	2597310	ME-F16 M/C	Tube ME Valve 34G SV	1,40	34G	V1-09-1	TR4		SV	
	160/80 - 15	2597310	ME-F16 M/C	Tube ME Valve 34G SV	1,40	34G	V1-09-1	TR4		SV	
	170/80 - 15	2597610	ME-H 15 M/C	Tube ME Valve V1-09-1 SV	1,90	34G	V1-09-1	TR4		SV	
	170/80-15	2597710	ME-15 M/C	Tube ME Valve V1-09-1	1,9	34G	V1-09-1	TR4			
	130/90 - 15	2597310	ME-F16 M/C	Tube ME Valve 34G SV	1,40	34G	V1-09-1	TR4		SV	
	140/90 - 15	2597310	ME-F16 M/C	Tube ME Valve 34G SV	1,40	34G	V1-09-1	TR4		SV	
	150/90 - 15	2597310	ME-F16 M/C	Tube ME Valve 34G SV	1,40	34G	V1-09-1	TR4		SV	
	16"	3.00 - 16	2598210	ME-C/D16 M/C	Tube ME Valve 34G	1,40	34G	V1-09-1	TR4		
		3.25 - 16	2598210	ME-C/D16 M/C	Tube ME Valve 34G	1,40	34G	V1-09-1	TR4		
		3.50 - 16	2598210	ME-C/D16 M/C	Tube ME Valve 34G	1,40	34G	V1-09-1	TR4		
110/90 - 16		2598110	ME-K16 M/C	Tube ME Valve V1-09-1	1,40	34G	V1-09-1	TR4			
120/90 - 16		2598110	ME-K16 M/C	Tube ME Valve V1-09-1	1,40	34G	V1-09-1	TR4			
130/90 - 16		2597310	ME-F16 M/C	Tube ME Valve 34G SV	1,40	34G	V1-09-1	TR4		SV	
MU90 - 16		2597310	ME-F16 M/C	Tube ME Valve 34G SV	1,40	34G	V1-09-1	TR4		SV	
130/90 - 16		2598110	ME-K16 M/C	Tube ME Valve V1-09-1	1,40	34G	V1-09-1	TR4			
160/70 - 16		2597310	ME-F16 M/C	Tube ME Valve 34G SV	1,40	34G	V1-09-1	TR4		SV	
110/80 - 16		2598210	ME-C/D16 M/C	Tube ME Valve 34G	1,40	34G	V1-09-1	TR4			
140/80 - 16		2597310	ME-F16 M/C	Tube ME Valve 34G SV	1,40	34G	V1-09-1	TR4		SV	
150/80 - 16		2597310	ME-F16 M/C	Tube ME Valve 34G SV	1,40	34G	V1-09-1	TR4		SV	
160/80 - 16		2597310	ME-F16 M/C	Tube ME Valve 34G SV	1,40	34G	V1-09-1	TR4		SV	
140/80 - 16		2597310	ME-F16 M/C	Tube ME Valve 34G SV	1,40	34G	V1-09-1	TR4		SV	
150/80 - 16		2597310	ME-F16 M/C	Tube ME Valve 34G SV	1,40	34G	V1-09-1	TR4		SV	
160/80 - 16		2597310	ME-F16 M/C	Tube ME Valve 34G SV	1,40	34G	V1-09-1	TR4		SV	
90/90 - 16		2598210	ME-C/D16 M/C	Tube ME Valve 34G	1,40	34G	V1-09-1	TR4			
100/90 - 16		2598210	ME-C/D16 M/C	Tube ME Valve 34G	1,40	34G	V1-09-1	TR4			
3.50 - 16		2597210	ME-E16 (B) M/C	Tube ME Valve V1-09-1	1,40	34G	V1-09-1	TR4			
4.60 - 16		2597210	ME-E16 (B) M/C	Tube ME Valve V1-09-1	1,40	34G	V1-09-1	TR4			
130/70 - 16		2597210	ME-E16 (B) M/C	Tube ME Valve V1-09-1	1,40	34G	V1-09-1	TR4			
120/80 - 16		2597210	ME-E16 (B) M/C	Tube ME Valve V1-09-1	1,40	34G	V1-09-1	TR4			
110/80 - 16		2597210	ME-E16 (B) M/C	Tube ME Valve V1-09-1	1,40	34G	V1-09-1	TR4			
130/90 - 16		2597310	ME-F16 M/C	Tube ME Valve 34G SV	1,40	34G	V1-09-1	TR4		SV	
140/90 - 16		2597310	ME-F16 M/C	Tube ME Valve 34G SV	1,40	34G	V1-09-1	TR4		SV	
150/90 - 16		2597310	ME-F16 M/C	Tube ME Valve 34G SV	1,40	34G	V1-09-1	TR4		SV	
130/90 - 16		2597310	ME-F16 M/C	Tube ME Valve 34G SV	1,40	34G	V1-09-1	TR4		SV	
140/90 - 16		2597310	ME-F16 M/C	Tube ME Valve 34G SV	1,40	34G	V1-09-1	TR4		SV	
17"		2.50 - 17	2596510	ME - C/D17	Tube ME Valve V1-09-1	1,40	34G	V1-09-1	TR4		
		2.75 - 17	2596510	ME - C/D17	Tube ME Valve V1-09-1	1,40	34G	V1-09-1	TR4		
		3.00 - 17	2596510	ME - C/D17	Tube ME Valve V1-09-1	1,40	34G	V1-09-1	TR4		
	4.10 - 17	2552010	ME-E17 M/C	Tube ME Valve V1-09-1	1,40	34G	V1-09-1	TR4			
	4.60 - 17	2552010	ME-E17 M/C	Tube ME Valve V1-09-1	1,40	34G	V1-09-1	TR4			
	4.50 - 17	2552110	ME-F17 (B) M/C	Tube ME Valve V1-09-1	1,40	34G	V1-09-1	TR4			
	5.10 - 17	2552110	ME-F17 (B) M/C	Tube ME Valve V1-09-1	1,40	34G	V1-09-1	TR4			
	190/50 - 17	2552410	ME-G17 M/C	Tube ME Valve V1-09-1	1,70	34G	V1-09-1	TR4			
	200/50 - 17	2552410	ME-G17 M/C	Tube ME Valve V1-09-1	1,70	34G	V1-09-1	TR4			
	210/50 - 17	2552410	ME-G17 M/C	Tube ME Valve V1-09-1	1,70	34G	V1-09-1	TR4			
	170/55 - 17	2552410	ME-G17 M/C	Tube ME Valve V1-09-1	1,70	34G	V1-09-1	TR4			
	180/55 - 17	2552410	ME-G17 M/C	Tube ME Valve V1-09-1	1,70	34G	V1-09-1	TR4			
	120/60 - 17	2552010	ME-E17 M/C	Tube ME Valve V1-09-1	1,40	34G	V1-09-1	TR4			
	120/65 - 17	2552010	ME-E17 M/C	Tube ME Valve V1-09-1	1,40	34G	V1-09-1	TR4			
	130/60 - 17	2552010	ME-E17 M/C	Tube ME Valve V1-09-1	1,40	34G	V1-09-1	TR4			

54/ TUBE AND VALVE FITMENT CHART

	Tyre size	IP code	Description		Thickness (mm)	Valve DIN	Valve ETRTO	Valve TRA	Valve Bend	Valve position
	150/60 - 17	2598010	ME-K17 M/C	Tube ME Valve V1-09-1	1,40	34G	V1-09-1	TR4		
	160/60 - 17	2598010	ME-K17 M/C	Tube ME Valve V1-09-1	1,40	34G	V1-09-1	TR4		
	170/60 - 17	2552410	ME-G17 M/C	Tube ME Valve V1-09-1	1,70	34G	V1-09-1	TR4		
	110/70 - 17	2552010	ME-E17 M/C	Tube ME Valve V1-09-1	1,40	34G	V1-09-1	TR4		
	120/70 - 17	2552010	ME-E17 M/C	Tube ME Valve V1-09-1	1,40	34G	V1-09-1	TR4		
	130/70 - 17	2552010	ME-E17 M/C	Tube ME Valve V1-09-1	1,40	34G	V1-09-1	TR4		
	130/70 - 17	2552110	ME-F17 (B) M/C	Tube ME Valve V1-09-1	1,40	34G	V1-09-1	TR4		
	140/70 - 17	2598010	ME-K17 M/C	Tube ME Valve V1-09-1	1,40	34G	V1-09-1	TR4		
	150/70 - 17	2598010	ME-K17 M/C	Tube ME Valve V1-09-1	1,40	34G	V1-09-1	TR4		
	160/70 - 17	2552410	ME-G17 M/C	Tube ME Valve V1-09-1	1,70	34G	V1-09-1	TR4		
	110/80 - 17	2552010	ME-E17 M/C	Tube ME Valve V1-09-1	1,40	34G	V1-09-1	TR4		
	120/80 - 17	2552010	ME-E17 M/C	Tube ME Valve V1-09-1	1,40	34G	V1-09-1	TR4		
	120/80 - 17	2552110	ME-F17 (B) M/C	Tube ME Valve V1-09-1	1,40	34G	V1-09-1	TR4		
	130/80 - 17	2552110	ME-F17 (B) M/C	Tube ME Valve V1-09-1	1,40	34G	V1-09-1	TR4		
	140/80 - 17	2598010	ME-K17 M/C	Tube ME Valve V1-09-1	1,40	34G	V1-09-1	TR4		
	150/80 - 17	2598010	ME-K17 M/C	Tube ME Valve V1-09-1	1,40	34G	V1-09-1	TR4		
	110/90 - 17	2552010	ME-E17 M/C	Tube ME Valve V1-09-1	1,40	34G	V1-09-1	TR4		
	110/90 - 17	2552110	ME-F17 (B) M/C	Tube ME Valve V1-09-1	1,40	34G	V1-09-1	TR4		
	120/90 - 17	2552010	ME-E17 M/C	Tube ME Valve V1-09-1	1,40	34G	V1-09-1	TR4		
	120/90 - 17	2552110	ME-F17 (B) M/C	Tube ME Valve V1-09-1	1,40	34G	V1-09-1	TR4		
	130/90 - 17	2598010	ME-K17 M/C	Tube ME Valve V1-09-1	1,40	34G	V1-09-1	TR4		
18"	2.25 - 18	2597110	ME-C18 M/C	Tube ME Valve V1-09-1	1,40	34G	V1-09-1	TR4		
	2.50 - 18	2597110	ME-C18 M/C	Tube ME Valve V1-09-1	1,40	34G	V1-09-1	TR4		
	2.75 - 18	2597110	ME-C18 M/C	Tube ME Valve V1-09-1	1,40	34G	V1-09-1	TR4		
	3.00 - 18	2109410	ME-D18 M/C	Tube ME Valve V1-09-1	1,40	34G	V1-09-1	TR4		
	3.25 - 18	2109510	ME-E18 M/C	Tube ME Valve V1-09-1	1,40	34G	V1-09-1	TR4		
	3.50 - 18	2109510	ME-E18 M/C	Tube ME Valve V1-09-1	1,40	34G	V1-09-1	TR4		
	3.60 - 18	2109410	ME-D18 M/C	Tube ME Valve V1-09-1	1,40	34G	V1-09-1	TR4		
	4.00 - 18	2109610	ME-F18 M/C	Tube ME Valve V1-09-1	1,40	34G	V1-09-1	TR4		
	4.10 - 18	2109510	ME-E18 M/C	Tube ME Valve V1-09-1	1,40	34G	V1-09-1	TR4		
	4.25 - 18	2109610	ME-F18 M/C	Tube ME Valve V1-09-1	1,40	34G	V1-09-1	TR4		
	4.25/85 - 18	2109510	ME-E18 M/C	Tube ME Valve V1-09-1	1,40	34G	V1-09-1	TR4		
	4.50 - 18	2109610	ME-F18 M/C	Tube ME Valve V1-09-1	1,40	34G	V1-09-1	TR4		
	4.60 - 18	2109510	ME-E18 M/C	Tube ME Valve V1-09-1	1,40	34G	V1-09-1	TR4		
	100/100 - 18	2597810	ME-CR 18F NHS M/C	Tube ME Valve 34G	3,00	34G	V1-09-1	TR4		
	110/100 - 18	2597810	ME-CR 18F NHS M/C	Tube ME Valve 34G	3,00	34G	V1-09-1	TR4		
	120/100 - 18	2597810	ME-CR 18F NHS M/C	Tube ME Valve 34G	3,00	34G	V1-09-1	TR4		
	280/35 - 18	2597910	ME-K18 M/C	Tube ME Valve V1-09-1	1,80	34G	V1-09-1	TR4		SV
	240/40 - 18	2597910	ME-K18 M/C	Tube ME Valve V1-09-1	1,80	34G	V1-09-1	TR4		SV
	300/35 - 18	2597910	ME-K18 M/C	Tube ME Valve V1-09-1	1,80	34G	V1-09-1	TR4		SV
	180/55 - 18	2597410	ME-G18 M/C	Tube ME Valve 34G	1,40	34G	V1-09-1	TR4		
	130/60 - 18	2109510	ME-E18 M/C	Tube ME Valve V1-09-1	1,40	34G	V1-09-1	TR4		
	160/60 - 18	2597410	ME-G18 M/C	Tube ME Valve 34G	1,40	34G	V1-09-1	TR4		
	170/60 - 18	2597410	ME-G18 M/C	Tube ME Valve 34G	1,40	34G	V1-09-1	TR4		
	110/70 - 18	2109510	ME-E18 M/C	Tube ME Valve V1-09-1	1,40	34G	V1-09-1	TR4		
	120/70 - 18	2109510	ME-E18 M/C	Tube ME Valve V1-09-1	1,40	34G	V1-09-1	TR4		
	130/70 - 18	2109510	ME-E18 M/C	Tube ME Valve V1-09-1	1,40	34G	V1-09-1	TR4		
	140/70 - 18	2109610	ME-F18 M/C	Tube ME Valve V1-09-1	1,40	34G	V1-09-1	TR4		
	150/70 - 18	2109610	ME-F18 M/C	Tube ME Valve V1-09-1	1,40	34G	V1-09-1	TR4		
	100/80 - 18	2109410	ME-D18 M/C	Tube ME Valve V1-09-1	1,40	34G	V1-09-1	TR4		
	110/80 - 18	2109510	ME-E18 M/C	Tube ME Valve V1-09-1	1,40	34G	V1-09-1	TR4		
	120/80 - 18	2109610	ME-F18 M/C	Tube ME Valve V1-09-1	1,40	34G	V1-09-1	TR4		
	130/80 - 18	2597810	ME-CR 18F NHS M/C	Tube ME Valve 34G	3,00	34G	V1-09-1	TR4		
	130/80 - 18	2109610	ME-F18 M/C	Tube ME Valve V1-09-1	1,40	34G	V1-09-1	TR4		
	140/80 - 18	2597810	ME-CR 18F NHS M/C	Tube ME Valve 34G	3,00	34G	V1-09-1	TR4		
	140/80 - 18	2109610	ME-F18 M/C	Tube ME Valve V1-09-1	1,40	34G	V1-09-1	TR4		
	150/80 - 18	2597410	ME-G18 M/C	Tube ME Valve 34G	1,40	34G	V1-09-1	TR4		
	90/90 - 18	2109410	ME-D18 M/C	Tube ME Valve V1-09-1	1,40	34G	V1-09-1	TR4		
	100/90 - 18	2109510	ME-E18 M/C	Tube ME Valve V1-09-1	1,40	34G	V1-09-1	TR4		
	110/90 - 18	2597810	ME-CR 18F NHS M/C	Tube ME Valve 34G	3,00	34G	V1-09-1	TR4		
	110/90 - 18	2109510	ME-E18 M/C	Tube ME Valve V1-09-1	1,40	34G	V1-09-1	TR4		

TUBE AND VALVE FITMENT CHART/55

	Tyre size	IP code	Description		Thickness (mm)	Valve DIN	Valve ETRTO	Valve TRA	Valve Bend	Valve position
	120/90 - 18	2597810	ME-CR 18F NHS M/C	Tube ME Valve 34G	3,00	34G	V1-09-1	TR4		
	120/90 - 18	2109610	ME-F18 M/C	Tube ME Valve V1-09-1	1,40	34G	V1-09-1	TR4		
	130/90 - 18	2597810	ME-CR 18F NHS M/C	Tube ME Valve 34G	3,00	34G	V1-09-1	TR4		
	130/90 - 18	2109610	ME-F18 M/C	Tube ME Valve V1-09-1	1,40	34G	V1-09-1	TR4		
19"	3.00 - 19	2596810	ME-E19 M/C	Tube ME Valve V1-09-1	1,40	34G	V1-09-1	TR4		
	3.25 - 19	2596610	ME-E19 M/C	Tube ME Valve V1-09-1	1,40	34G	V1-09-1	TR4		
	3.50 - 19	2596610	ME-E19 M/C	Tube ME Valve V1-09-1	1,40	34G	V1-09-1	TR4		
	3.60 - 19	2596810	ME-E19 M/C	Tube ME Valve V1-09-1	1,40	34G	V1-09-1	TR4		
	4.10 - 19	2596610	ME-E19 M/C	Tube ME Valve V1-09-1	1,40	34G	V1-09-1	TR4		
	110/80 - 19	2596910	ME-CR 19E NHS M/C	Tube ME Valve 34G	2,50	34G	V1-09-1	TR4		
	110/80 - 19	2596610	ME-E19 M/C	Tube ME Valve V1-09-1	1,40	34G	V1-09-1	TR4		
	120/80 - 19	2596910	ME-CR 19E NHS M/C	Tube ME Valve 34G	2,50	34G	V1-09-1	TR4		
	120/80 - 19	2596610	ME-E19 M/C	Tube ME Valve V1-09-1	1,40	34G	V1-09-1	TR4		
	130/80 - 19	2596910	ME-CR 19E NHS M/C	Tube ME Valve 34G	2,50	34G	V1-09-1	TR4		
	130/80 - 19	2596610	ME-E19 M/C	Tube ME Valve V1-09-1	1,40	34G	V1-09-1	TR4		
	90/90 - 19	2596810	ME-E19 M/C	Tube ME Valve V1-09-1	1,40	34G	V1-09-1	TR4		
	100/90 - 19	2596910	ME-CR 19E NHS M/C	Tube ME Valve 34G	2,50		V1-09-1	TR4		
	100/90 - 19	2596810	ME-E19 M/C	Tube ME Valve V1-09-1	1,40	34G	V1-09-1	TR4		
	100/90 - 19	2596610	ME-E19 M/C	Tube ME Valve V1-09-1	1,40	34G	V1-09-1	TR4		
	110/90 - 19	2596910	ME-CR 19E NHS M/C	Tube ME Valve 34G	2,50	34G	V1-09-1	TR4		
	110/90 - 19	2596610	ME-E19 M/C	Tube ME Valve V1-09-1	1,40	34G	V1-09-1	TR4		
21"	2.50 - 21	2109710	ME-C21 M/C	Tube ME Valve V1-09-1	1,40	34G	V1-09-1	TR4		
	2.75 - 21	2109710	ME-C21 M/C	Tube ME Valve V1-09-1	1,40	34G	V1-09-1	TR4		
	3.00 - 21	2597010	ME-CR 21D NHS M/C	Tube ME Valve 34G	2,50	34G	V1-09-1	TR4		
	3.00 - 21	2109710	ME-D21 M/C	Tube ME Valve V1-09-1	1,40	34G	V1-09-1	TR4		
	3.25 - 21	2597010	ME-CR 21D NHS M/C	Tube ME Valve 34G	2,50	34G	V1-09-1	TR4		
	3.25 - 21	2109710	ME-D21 M/C	Tube ME Valve V1-09-1	1,40	34G	V1-09-1	TR4		
	80/100 - 21	2597010	ME-CR 21D NHS M/C	Tube ME Valve 34G	2,50	34G	V1-09-1	TR4		
	80/100 - 21	2109710	ME-D21 M/C	Tube ME Valve V1-09-1	1,40	34G	V1-09-1	TR4		
	80/90 - 21	2109710	ME-C21 M/C	Tube ME Valve V1-09-1	1,40	34G	V1-09-1	TR4		
	90/90 - 21	2597010	ME-CR 21D NHS M/C	Tube ME Valve 34G	2,50	34G	V1-09-1	TR4		
	90/90 - 21	2109710	ME-D21 M/C	Tube ME Valve V1-09-1	1,40	34G	V1-09-1	TR4		
	90/100 - 21	2597010	ME-CR 21D NHS M/C	Tube ME Valve 34G	2,50	34G	V1-09-1	TR4		

56/ TUBE AND VALVE FITMENT CHART

Size / Valve	Tyre
ME-D10 (V1-09-1)	3.00 - 3.50 - 100/80 - 110/80 - 90/90
ME-D10 (V6-02-1)	3.00 - 3.50 - 100/80 - 110/80 - 90/90
ME-D10 (V1-08-1)	3.00 - 3.50 - 100/80 - 110/80 - 90/90
ME-F15/16 (V1-09-1)	MT90 - MU90 - 160/70 - 140/80 - 160/80 - 140/90 - 150/90 - MT90 - MU90 - 160/70 - 140/80 - 150/80 - 160/80 - 130/90 - 140/90
ME-G15 (V1-09-1)	180/70 - 200/70
ME-F16 (V1-09-1)	140/80 - 130/90 - 140/90 - 150/90 - MT90 - MU90 - 160/70 - 140/80 - 150/80 - 160/80 - 130/90 - 140/90
ME-H1 15 (V1-09-1)	180/70 - 200/70 - 170/80
6 E 16 (V1-07-1)	2 -1/4
ME-C/D16 (V1-09-1)	3.00 - 3.25 - 3.50 - 110/80 - 90/90 - 100/90
ME-E16 (V1-09-1)	3.50 - 4.60 - 130/70 - 120/80 - 110/90 - 120/90 - 130/90
7 A 16 (V1-09-1)	2.25 - 2.50 - 2.75 - 2-1/2 - 2-1/4 - 2-3/4
ME-E17 (V1-09-1)	4.10 - 4.60 - 130/60 - 110/70 - 120/70 - 130/70 - 110/80 - 120/80 - 110/90 - 120/90
ME-F17 (V1-09-1)	4.50 - 5.10 - 150/60 - 160/60 - 130/70 - 140/70 - 150/70 - 120/80 - 130/80 - 140/80 - 150/80 - 110/90 - 120/90 - 130/90
7 A 17 (V1-09-1)	2.25 - 2.50 - 2-1/2 - 2-1/4 - 2-3/4
ME-G17 (V1-09-1)	190/50 - 200/50 - 210/50 - 170/55 - 180/55 - 170/60 - 160/70
ME-K18 (V1-09-1)	280/35 - 240/40
ME-C18 (V1-09-1)	2.25 - 2.50 - 2.75
ME-D18 (V1-09-1)	3.00 - 3.60 - 100/80 - 90/90
ME-E18 (V1-09-1)	3.25 - 3.50 - 4.10 - 4.25/85 - 4.60 - 130/60 - 110/70 - 120/70 - 110/80 - 100/90 - 110/90
ME-F18 (V1-09-1)	4.00 - 4.25 - 4.50 - 140/70 - 150/70 - 120/80 - 130/80 - 140/80 - 120/90 - 130/90
ME-CR 18F NHS (V1-09-1)	100/100 - 110/100 - 120/100 - 130/80 - 140/80 - 110/90 - 120/90 - 130/90
ME-G18 (V1-09-1)	180/55 - 160/60 - 170/60 - 150/80
ME-D19 H (V1-09-1)	3.00 - 3.60 - 90/90 - 100/90
ME-E19 (V1-09-1)	3.00 - 3.60 - 90/90 - 100/90
ME-E19 (V1-09-1)	3.25 - 3.50 - 4.10 - 110/80 - 120/80 - 130/80 - 100/90 - 110/90
ME-CR 19E NHS (V1-09-1)	110/80 - 120/80 - 130/80 - 100/90 - 110/90
ME-C21 (V1-09-1)	2.50 - 2.75 - 80/90
ME-D21 (V1-09-1)	3.00 - 3.25 - 80/100 - 90/90
ME-CR 21D NHS (V1-09-1)	3.00 - 3.25 - 80/100 - 90/90

Tubes

TUBE	VALVE	IP CODE	NOTE
ME-D10V1-09-1	V1-09-01	2552710	2.50-10, 2.75-10
ME-C/D14V1-09-1(*)	V1-09-01	2111010	80/100-14
ME-G15V6-02-2	V6-02-2	2597510	180/70-15, 200/70-15, 170/80 -15
ME-H15SV V1-09-1	V1-09-01	2597610	180/70-15, 200/70-15, 170/80 -15
ME 15V1-09-1	V1-09-01	2597710	180/70-15; 170/80-15; 200/70-15
ME-C16V1-09-1	V1-09-01	2598210	3.00-16, 3.25-16, 3.50-16, 90/90-16, 100/90-16, 110/80-16
ME-E16(B)V1-09-1	V1-09-01	2597210	3.50-16, 4.60-16, 120/80-16, 130/70-16
ME-F15/16SV V1-09-1	V1-09-01	2597310	130/90-15, 140/90-15, 150/90-15, 140/80-15, 160/80-15, 160/70-15, 130/90-16, 140/90-16, 150/90-16, 140/80-16, 150/80-16, 160/80-16, MU90-16, 160/70-16
ME-K16V1-09-1	V1-09-01	2598110	110/90-16; 120/90-16; 130/90-16
ME-C/D17V1-09-1	V1-09-01	2596510	2.50-17, 2.75-17, 3.00-17, 100/80-17
ME-E17V1-09-1*	V1-09-01	2552010	4.00-17, 4.60-17, 110/80-17, 110/90-17, 120/70-17, 120/80-17, 120/90-17, 130/70-17, 110/70-17
ME-F17 (B)V1-09-1	V1-09-01	2552110	5.10-17, 130/80-17, 130/90-17, 140/70-17, 140/80-17, 150/70-17, 160/60-17, 160/70-17
ME-G17V1-09-1*	V1-09-01	2552410	160/70-17, 170/60-17, 170/55-17, 180/55-17, 190/50-17, 200/50-17, 210/50-17
ME-K17 M/C	V1-09-01	2598010	130/90-17, 140/80-17, 150/80-17, 140/70-17, 150/70-17, 150/60-17, 160/60-17
ME-C18V1-09-1	V1-09-01	2597110	2.25-18, 2.50-18, 2.75-18
ME-CR18F NHSV1-09-1	V1-09-01	2597810	100/100-18, 110/100-18, 120/100-18
ME-C/D18TR4EN(*)	V1-09-01	2109410	3.00-18, 3.60-18, 90/90-18, 100/80-18
ME-E18 Y M/CV1-09-1(*)	V1-09-01	2109510	3.25-18, 3.50-18, 4.10-18, 4.60-18, 4.25/85-18, 110/70-18, 120/70-18, 130/70-18, 100/90-18, 110/80-18, 110/90-18, 90/100-18
ME-F18 YTR4EN(*)	V1-09-01	2109610	4.00-18, 4.25-18, 4.50-18, 120/80-18, 130/80-18, 120/90-18, 130/90-18, 140/70-18, 140/80-18, 150/70-18
ME-K18SV V1-09-1	V1-09-01	2597910	280/35-18; 240/35-18
ME-G18 M/C	V1-09-01	2597410	150/80-18, 160/70-18, 170/70-18, 180/55-18
ME-CR19E NHSV1-09-1	V1-09-01	2596910	100/90-19, 110/90-19, 110/80-19, 120/80-19, 130/80-19
ME-D19V1-09-1	V1-09-01	2596810	3.00-19, 3.60-19, 90/90-19, 100/90-19
ME-E19V1-09-1	V1-09-01	2596610	3.25-19, 3.50-19, 4.10-19, 110/90-19, 110/80-19, 120/80-19, 130/80-19
ME-CR21D NHSV1-09-1	V1-09-01	2597010	3.00-21, 3.25-21, 80/100-21, 90/90-21
ME-C/D21TR4EN(*)	V1-09-01	2109710	2.50-21, 2.75-21, 3.00-21, 3.25-21, 80/90-21, 90/90-21

Flap

Flap description:

- 1 - First number refers to the rim expressed in inches
- 2 - The second number is the nomina width expressed in millimeters
- 3 - The presence of a letter states a different length, higher than the standard

FLAP	IP CODE	NOTE
15/46	9023000	
16-17/23	9017200	
16-17/28	9017500	
16-17/28 OV	9017600	
17/42	9022400	
17/42 L	9168400	
18-19/23	9017700	
18-19/23 L	9168300	
18-19/28	9017800	
18-19/28 L	9167900	
19/30	9112600	
21/28	9017900	
21/28 L	9168000	

Marking and Designation System

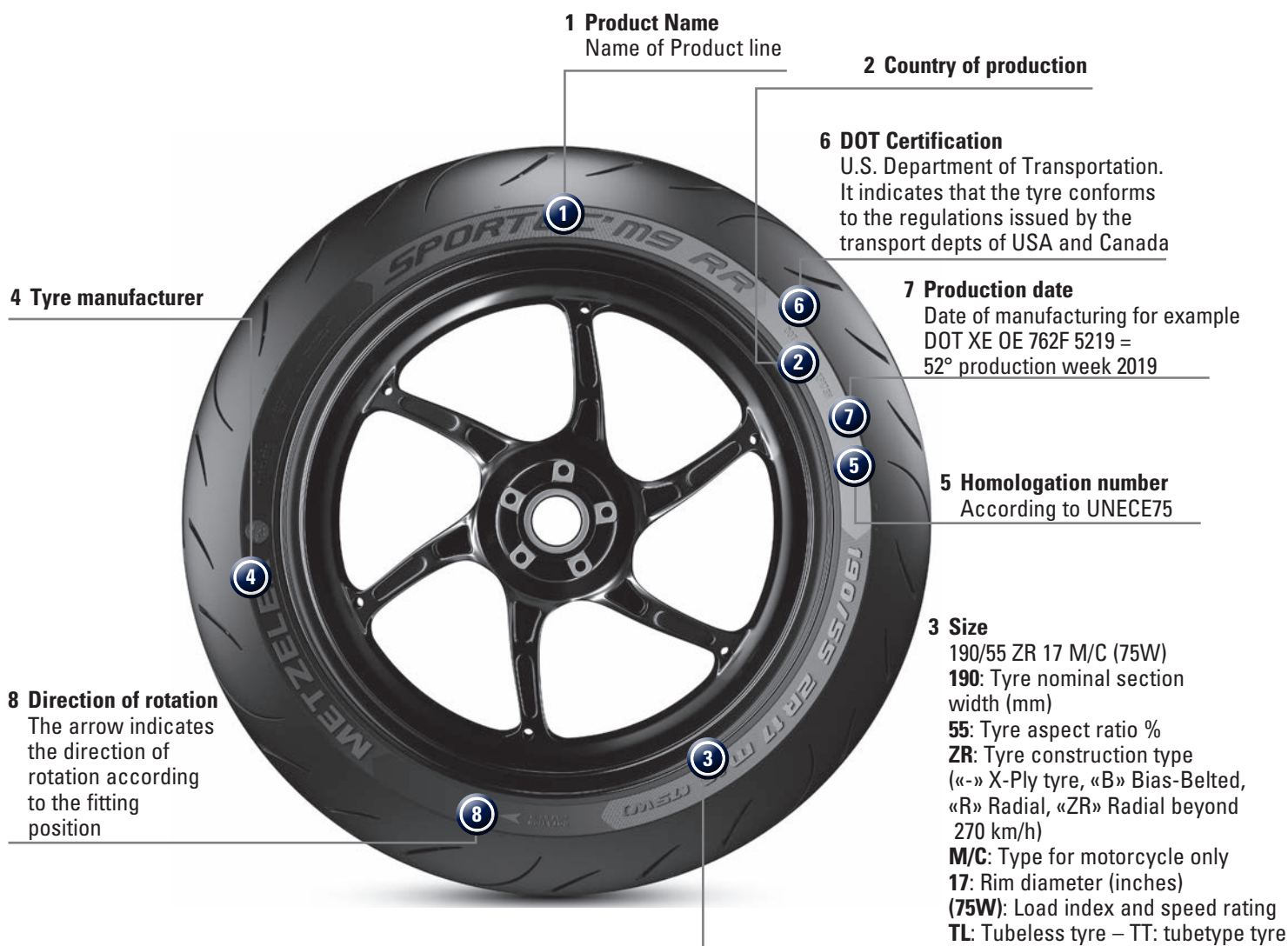

LOAD CAPACITY

The maximum load in lbs is written on every METZELER street tyre together with the corresponding maximum cold inflation pressure in psi. In the tyre service description in accordance with the new tyre designation the maximum load is also given through the load index code.

Please refer to the conversion table in the "Riding Safety" section for translation of load index to real kg-load/lbs-load. Some tyres show in the service description the additional markings "reinf." which is equivalent to "6 PR" or "Load Range C" and indicates a reinforced structure for an increased load capacity. This higher load is already contained in the maximum load inscription. For higher than indicated load capacities in the case of reduced speed consult METZELER.

SPEED RATING

The max. permitted speed for a tyre is indicated by a specific speed index-code (Please refer to the "Riding safety" section for conversion of speed index-code into real km/h or mph). For tyres suitable for speeds above 210 km/h (130 mph) the actual max. speed is indicated in the technical data part.

A closer look at METZELER Motorcycle Technology

Bias tyre

Also indicated as conventional or x-ply tyre. The structure of this tyre is made of a carcass where, depending on the different speed and load specifications, two or more layers are overlapped. Each layer is made of textile cords coated into rubber and the overlap angle is designed in order to confer the tyre the required dynamic characteristics.

BIAS TYRE



Bias-belted tyre

The structure of those tyres is realized with a conventional carcass and a belt made of two or more crossed layers. The difference between carcass and belt is given by the different goals that they have to fulfil and consequently the different materials that are used: the belt is made mainly from Aramide and it's function is reduce the dynamic deformation caused by centrifugal forces, while the carcass has to mainly give the tyre its stiffness and load carrying capacity.

BIAS - BELTED TYRE



Belted tyre with radial carcass

The main difference of the bias-belted tyre is given by the structure of the carcass that in this case is radial. This means that its cords are wrapped radially around the tyre, from one bead to the other. In this way low-section tyres can be realized, giving big advantages in terms of cornering stability, reduced weight and high-speed performance.

Its extremely high rigidity and the possibility to tune the winding spacing giving a differentiated stiffness distribution from shoulder to crown.

BELTED TYRE WITH RADIAL CARCASS (90 DEGREES)



0° steel belt tyre with radial carcass

Patented technology by METZELER realizing the structure of both front and rear tyre using a radial carcass and a single layer belt made of steel. Considering the rolling direction of the tyre, the belt is wound circumferentially around the carcass giving an angle close to 0°. The advantages coming from the use of steel are its extremely high rigidity and the possibility to tune the winding spacing giving a differentiated stiffness distribution from shoulder to crown.

0° - STEEL BELTED TYRE WITH RADIAL CARCASS (90 DEGREES)



Tyre Safety Maintenance and Mounting Advice

TYRE PRESSURE

Always inflate the tyre to the correct pressure. Be sure to check cold inflation pressure frequently, i.e. once a week. Although most motorcyclists love to work on their bikes, they seldom remember to check tyre pressures.

Correct tyre pressure, however, is critical for safe handling. Overinflation or extreme tyre pressure will impair your riding comfort and decrease the contact of the tyre with the road. Underinflation or too little air pressure will result in poor handling and the bike will be inclined to "wander". Improper and insufficient tyre pressure will also cause rapid tyre wear, an increase in fuel consumption, lower top speed, and provide less control. Remember to check the inflation pressure of your tyres weekly. You will find the correct pressure in the operating manual of the motorcycle. Use METZELER's information only as reference. Attention: When the recommended pressure has been changed for use off-road (race track, off-road), it must be reset to the correct value before riding on the street.

CAUTION

To avoid the danger of air leakage, use only balancing weights which are approved by the motorcycle manufacturer, e.g. spoke nipple weights, lead wire or self adhesive rim weights. We do not recommend the use of liquid balancers or liquid balance/sealers. METZELER does not guarantee tyres into which these have been injected.

DIFFERENT CONSTRUCTIONS

We have three distinct construction types: Bias tyres ("–"), bias belted tyres ("B"), and radial tyres ("R").

The tyre's ability to carry side and peripheral forces differs for each distinct construction type. Therefore, a combination of different construction types can influence the motorcycle's performance. Only the tyre combinations listed in the motorcycle manufacturers fitment charts are allowed.

DIFFERENT PATTERNS

METZELER offers both front and rear tyres in different profiles and for different types of use, so that the front and rear tyres can complement each other. It is not allowed to fit, for example, a street tyre with an off-road tyre.

DYNAMOMETER USE

Dynamometer measurements place extreme loads on tyres. It's possible that damage, often invisible, can be caused during the testing which can lead, under certain conditions, to a failure later. Motorcycle tyres that have been used on a dynamometer must not be used later on the road.

FRONT AND REAR BRAND

Using different brands of front and rear tyres simultaneously may cause problems. Regrettably, we cannot test METZELER tyres in combination with all our competitors' tyres, and therefore, we urge you - for safety reasons - to use METZELER tyres on both the front and rear axle.

LIQUID SEALANTS

We do not recommend the use of liquid sealants. Liquid sealants are a form of temporary repair which can adversely affect ply material and bide any secondary damage caused by the penetrating object.

LOAD CAPACITY

Tyres are offered in different load carrying capacities. It is extremely important not to exceed the max. load rating. You must take the weight of the motorcycle, the weight of any optional equipment, as well as the weight of a passenger and the total has not to be higher than the approved tyres load capacity indicated by the motorcycle manufacturer. A tyre's load carrying ability can be reduced by underinflation.

NEW TYRES - NEW TUBES

METZELER tubes fit with METZELER tyres. Tubes are a vital part of the tube-type wheel assembly. They should be handled with care. A new tube should be fitted at the same time that a new tyre is fitted. An old stretched tube fitted into a new tyre, can cause it to crease and fail. Always make sure that your tyre size is printed on the tube, thereby ensuring that you have the correct tube size.

NEW TUBELESS TYRES - NEW VALVES AND VALVE STEMS

When fitting a new tubeless tyre onto the tubeless-type rim of your motorcycle you should always use a new valve. We highly recommend this because the body of valves used in tubeless rims are made out of a rubber material, which will harden and age with the time. The aging and hardening process is accelerated when the valve comes into contact with oil, ozone and other hostile elements. When braking or accelerating, the valve is bent by dynamic forces. An old valve could brake under such forces and cause a sudden air loss. METZELER recommends the use of short valve stems. At high speeds the strong centrifugal forces work on the valve and the tension of the spring. The air pressure is not sufficient to keep the valve closed. Due to smaller mass of short valve stems (compared to long valve stems) the valve remains closed at high speeds.

METZELER TUBELESS TYRES

When installing a tube in a METZELER tubeless tyre, never tighten the valve stem lock nut until the tyre is properly seated and inflated to the proper riding pressure. Whenever you install a tube, be sure not to pinch the tube and remember to dust the tube with talcum powder. Always use a valve cap.

RADIAL TYRES

The fitment of tubes in radial tyres is possible under certain specific conditions. You will find the correct indications in the operating manual of the motorcycle. It is not recommended to fit a tube in a Radial Tubeless tyre marked "ZR".

REPLACING A WORN TYRE

Remember, precise matching of front and rear tyres is necessary to obtain optimum performance and handling. When fitting a new front tyre, check the wear on the rear tyre. A new front tyre combined with worn rear tyre may cause instability. Please bear in mind that many other factors can affect the handling of a motorcycle, including the weight and height of the rider, and the addition of luggage of fairings. Please consult the motor-cycle manufacturer before making non standard modifications.

RIMS

The section "Technical Data" informs about all the permitted rims for that size; the one written in bold is the suggested one. Motorcycle tyres must be fitted to motorcycle rims only. New tyre marking description foresees the M/C symbol on the sidewall to identify tyres that can be fitted on motorcycle rims only. The correct rim width is important for handling characteristics and stability. Fitting a tyre to a too narrow or wide rim changes the tyre profile and gives a negative effect to the overall tyre performance.

RUN-IN

In order for your new tyres to provide optimum performance, all new tyres should be ridden very cautiously for the first 100-200 kms. Immediately after new tyres are mounted, sudden acceleration, heavy braking, and hard cornering must be avoided until the 100-200 Kms run-in period is completed.

SPEED RATINGS

The speed index (SI) indicates the maximum speed the tyre is homologated for. Even if METZELER tyres allow high speed performance ability, we do not recommend the use of any of our products in excess of legal speed limits. Tyres can have the same pattern and size, but a different speed rating, this is due to the tyre construction and therefore they will perform differently. When selecting your new METZELER motorcycle tyres, be sure to choose the right speed rating. Before buying, consult the fitment chart and the technical data in your METZELER manual or call us directly. Maximum speed capability varies from size to size, but is always equal to or greater than that of the original equipment tyres when fitted in accordance with METZELER recommendations. The use of a tyre with a higher speed rating (e.g. "H" instead of "S") is allowed only if it listed in the fitment chart. Especially in cases where the speed rating exceed 210 km/h, the METZELER recommendations must be respected.

SUFFICIENT CLEARANCE

Before installing wheels/tyres onto your motorcycle be sure to check clearances. Indicated sizes will vary between brands and models. Remember to consult the motorcycle manufacturer before you decide to mount sizes other than those specified in this booklet. The physical dimensions must provide for adequate clearance fenders, swing arm etc. If you increase the tyre size, it may be necessary to increase the width of the rim as well. If you increase the tyre size and/or rim width, it is very important to rotate the wheel and examine it closely for ample clearance. Please refer to our "technical data" section for more information on the dynamic radius of the tyre.

TUBELESS TYRES

Tubeless tyres require a special bead seat, because the beads have to form an airtight seal on the rim. Not all cast wheels, aluminium or magnesium, are suitable for tubeless tyre fitment. Do not mount tyres without tubes, unless the wheel manufacturer recommends it. If a tube is inserted, it is then possible to fit a tubeless tyre to a tubetype rim.

TYRE MOUNTING - IMPORTANT INFORMATION

WARNING

Tyres are only to be used on vehicles for which motorcycle tyres were originally approved by the manufacturer. Any other use can be dangerous. Check if the tyre has directional arrows. If it does, you must mount the tyre so that the arrow points in the direction of rotation. Some METZELER tyres have a red dot on the side wall. This indicates the lightest point, and should be positioned next to the valve. To lubricate the bead, use tyre mounting lubricant or soapy water. To seat the bead: remove the valve stem core and inflate the tyre. For safety reasons do not inflate motorcycle tyres to more than 40 psi (2,8 bar); for scooters tyres do not exceed 150 % of the indicated maximum pressure. Be sure to reinstall the valve stem core and inflate the tyre/tube to the recommended riding pressure. Check the bead control lines for proper seating. If the beads are not properly seated, you will have to deflate the tyres/tubes and repeat the above procedure.

TREAD DEPTH

Legally the tyre has to be changed accordingly to the national law. METZELER recommends changing tyres when the remaining tread depth is below 2 mm.

REGROVING

It is not permitted to regrove or cut the tread pattern of motorcycle tyres, as this might affect negatively the riding performance and safety.

TYRE REPAIR

Tubeless tyres: Due to the specific regulations of different national governments, we can not give a general recommendation regarding tyre repair. Please refer to your distributor for information on your country's regulations. In case you are allowed to repair a tyre, we recommend that you repair only small punctures which are restricted to the tread area, by using a mushroom head type plug. The repairer is solely responsible for the repair and any instructions given to the user concerning the repaired tyre. Repaired tubeless tyres should never be used with a tube. **Tubetype tyres:** Tube repair is not permitted. Punctured tubetype tyres must have a new tube fitted. If punctured, in addition to having the replaced, the tyre and the rim have to be inspected by an expert. The puncture in the tyre should be repaired by a local vulcanisation, executed by a tyre repairer, so as to prevent moisture from attacking the tyre casing. The repairer is solely responsible to the user for the repair and any inspection of the repaired tyre.

TYRE SELECTION

When choosing your new METZELER motorcycle tyres, you must make sure that they meet the requirements of your motorcycle and that they are suitable for the types of road you intend to ride on.

VALVE CAPS

Centrifugal forces work on the valve stem. At high speeds they have the same effect as pushing on the valve with your finger. The tyre can deflate. The valve cap is the only part preventing it. Normally this phenomenon happens only at very high speeds. But an old or low quality valve stem can open at speeds lower than 200 km/h. Therefore the cap should always be tightly closed. METZELER suggests the use of airtight metal caps with rubber seal.

VEHICLE FITMENT AND SIZE MATCHING

When choosing tyres always make sure that the selected tyres matches the sizes, load capacity and speed index of the homologated tyre recommended by the vehicle manufacturers:

- Load and speed index must not be lower as indicated in the operating manual of the motorcycle.
- When fitting a new tyre check that there is no interfering with any mechanical parts of the vehicle especially at different running conditions.

NOTE:

Variations of tyre size from those indicated by vehicle manufacturers, even if technically possible, must be in accordance with existing local regulations.

WHEEL ALIGNMENT

Be sure to align your wheels every time the rear wheel is removed or the chain adjusted. Every rotation of an incorrectly aligned wheel results in additional tread wear, decreases tyre mileage, and affects steering and cornering.

WHEEL BALANCING

Elastic bodies like tyres, cannot be constructed in a perfect, circular form, with perfect balance. Therefore, be sure to balance a new tyre after installing it. There are two ways to balance a tyre: static and dynamic balancing. Static balancing can be performed without rotating the wheel, and also measures the deviation of masses with respect to the wheel's center plane. METZELER recommends dynamic balancing for rims over 2,5 inches in width.

STORAGE INSTRUCTIONS

Receipt of tyres – Area of conservation

In bad weather conditions, unloading at the time of receipt must be carried out in a covered area; in any event, if water is found inside the tyres, this must be removed immediately. Unloading must not be carried out by dropping the tyres or by any other method which could damage the quality or visual aspect of the tyres. Tyres must not be moved by inserting the forks of a fork lift truck through the center of a tyre which could damage the bead area. Tyres must be stored inside a clean, dry and ventilated area, protected from direct sunlight or other source of artificial light (illumination must be realized with lamps of low ultraviolet and infrared emission). In the case of temporary external storage, the tyres must be covered (eg. with an impermeable opaque material) and protected from contact with water and humidity.

Temperature

The storage temperature must be less than 35°C and preferably less than 25°C. A temperature greater than 50°C, especially if stock rotation is not sufficient, can result in accelerated forms of deterioration, such as to reduce the duration in use of the tyre. Avoid contact with heaters and radiators. Very low temperatures in the storage area are not in themselves damaging, but can provoke rigidity of the tyre.

In this case, they must not be deformed during movement or fitting. If they are destined to be used immediately they are released from storage, it is necessary to keep them for a few hours in an area with a temperature of approximately 20°C.

Oxygen, ozone and chemical substances

Appliances which generate ozone must not be introduced into the storage area, also gas and vapors from combustion which can generate ozone via photo-chemical processes must be excluded from the area. Neither the area or the equipment in the storage location must present traces of solvents, inflammable materials, lubricants, chemical products, acids, disinfectants, rubber solutions, etc. which could prejudice not only the visual aspect but also the characteristics of the product.

Deformation

Tyres must not be submitted to any deformation due to tension or compression.

Criteria for storage

Storage for long periods

The best method for storage is vertically in rows of one tyre high, on racks, positioned at least 10 cm from ground level, with the sidewalls positioned vertically, so that the profile is not altered.

The vicinity or stacking of other racking or pallets must not deform the profile of the tyres. The number of tyres per row must be such as to not compromise the sidewalls.

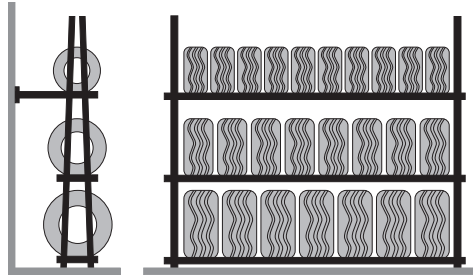

Short term storage

Up to 4 weeks, tyres can be stored in stacks, one on top of the other, preferably on a fixed rack or on stackable pallets, periodically reforming the stack inverting the order of the tyres. In all cases when tyres are stored in stacks, it is necessary to ensure that there is no partial misplacement from the vertical plane, in order to avoid any permanent deformation of the lower tyres in the stack.

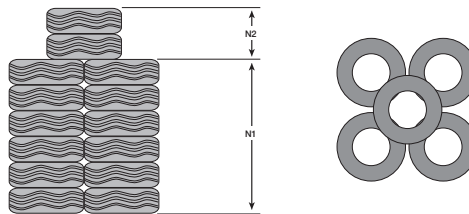

Inner tubes and valves

Whether inner tubes are supplied by the producer in single boxes, large boxes or wrapped in plastic film, it is always preferable to maintain the original packaging.

In alternative they can be stored also slightly inflated, inserted within the tyre, or piled deflated, up to a maximum height of 50 cm, on racking shelves with a closed base, accurately avoiding that the valve can damage the surface of the tube when squashed under the pressure of their own weight.

Ensure that the tubes do not overlap the edge of the plane on which they are stored to avoid accidental laceration.

It is not recommended to store on slatted pallets because the pressure applied to the tubes will not be uniform. Do not hang inner tubes during storage. Valves should be stored in their packaging in a clean, well ventilated and dry location.

Flaps

Flaps should preferably be placed within the tyre together with the inner tube. If they are stored separately, they should be placed horizontally, in a pile on a shelf, protected from dust, grease, humidity, ozone and direct sunlight.

To avoid deformation and stretching they must not be hung up in any way.

Stock rotation

The storage location must be organized in such a way as to guarantee constant stock rotation, limiting to the minimum the storage period of the tyres. Products which enter storage first must be the first to leave. First in, first out.

64/ TECHNICAL DATA TO STANDARD

Category	Rim	Description	Pattern Set	Application	F/R	IP Code	Footnote	Measuring Rim width	Permitted Rim width range	Max width in service	Diameter in service	Centrifugal radius at V-Max (W=240 km/h)	Rolling Circumference +/- 2%	Load capacity (kg)	V-max	Tube
On Road	14	100/80 - 14 M/C 48S TL	Sportec Street	Scooter	REAR	2716400	7	-2.50-	2.15-2.75	114	528	266	1558	212	180	-
	15	130/90 - 15 M/C 66S TL	Perfect ME 77	Classic	REAR	1268200	7	-3.00-	3.00-3.50	147	631	320	1857	300	180	ME F16
		130/90 - 15 M/C 66S TL	Lasertec	Cruising	REAR	1806700	7	-3.00-	3.00-3.50	147	631	320	1857	300	180	ME-F16
		140/90 - 15 M/C 70S	Perfect ME 77	Classic	REAR	0747300		-3.50-	2.75-3.75	158	651	330	1912	335	180	ME-F16*; ME F15/16**
		140/90 B 15 M/C 70H TL	ME 888 Marathon Ultra	Cruising	REAR	2408700	7	-3.50-	2.75-3.75	158	651	333	1912	335	210	ME-F16*; ME F15/16**
		150/90 B 15 M/C 80H reinf TL	ME 888 Marathon Ultra	Cruising	REAR	2616500	7	-3.50-	3.00-4.25	171	669	344	1966	450	210	ME-F16*; ME F15/16**
		160/80 - 15 M/C 74S TT	ME 888 Marathon Ultra	Cruising	REAR	3134400		-3.75-	3.00-4.50	184	655	332	1924	375	180	ME F15/16
		170/80 B 15 M/C 77H TL	ME 888 Marathon Ultra	Cruising	REAR	2318400	7	-4.00-	3.50-4.50	193	673	345	1972	412	210	ME H1 15
		170/80 B 15 M/C 77H TL	ME 888 Marathon Ultra WW	Cruising	REAR	2407900	7	-4.00-	3.50-4.50	193	673	345	1972	412	210	ME H1 15
		180/70 B 15 M/C 76H TL	ME 888 Marathon Ultra	Cruising	REAR	2703100	7	-5.00-	4.25-5.50	205	651	333	1912	400	210	ME G 15**; ME H1 15*
		200/70 B 15 M/C 82H TL	ME 888 Marathon Ultra	Cruising	REAR	3134500	7	-5.50-	4.50-6.25	229	681	349	1996	475	210	ME G 15**; ME H1 15*
	16	100/90 - 16 M/C 54H TL	Roadtec 01	Sport Touring	FRONT	3240900	7	-2.50-	2.15-2.75	114	598	305	1770	212	210	ME C/D 16
		110/90 - 16 M/C 59S	Perfect ME 77	Classic	FRONT	1016500	7	-2.50-	2.15-3.00	125	618	312	1824	243	180	ME K 16
		110/90 - 16 M/C 59S	Perfect ME 77	Classic	FRONT	1016500		-2.50-	2.15-3.00	125	618	312	1824	243	180	ME K 16
		110/90 - 16 M/C 59S TL	Perfect ME 77	Classic	REAR	1077700	7	-2.50-	2.15-3.00	125	618	312	1824	243	180	ME K 16
		110/90 - 16 M/C 59S TL	Perfect ME 77	Classic	REAR	1077700		-2.50-	2.15-3.00	125	618	312	1824	243	180	ME K 16
		110/90 - 16 M/C 59V TL	Roadtec 01	Sport Touring	FRONT	3241000	3/7/8	-2.50-	2.15-3.00	125	618	318	1824	243	240	ME K 16
		120/80 VB 16 M/C (60V) TL	Lasertec	Cruising	FRONT	1531100	3/7/8	-2.75-	2.50-3.00	134	612	314	1806	250	250	ME E 16 (B)
	120/90 - 16 M/C 63H TL	Perfect ME 77	Classic	REAR	0133100	7	-2.75-	2.50-3.00	134	638	325	1878	272	210	ME K 16	
	130/70 ZR 16 M/C (61W) TL	Sportec M7 RR	Sport	FRONT	3865600	4/7/8	-3.50-	3.50-4.00	143	600	303	1776	257	280	ME E 16 (B)	
	130/90 - 16 M/C 67H TL	Perfect ME 77	Classic	FRONT	3139700	7	-3.00-	2.50-3.50	147	656	335	1933	307	210	ME-F16*; ME F15/16**	
	130/90 - 16 M/C 67H TL	ME 888 Marathon Ultra	Cruising	FRONT	2318000	7	-3.00-	2.50-3.50	147	656	335	1933	307	210	ME-F16*; ME F15/16**	
	130/90 - 16 M/C 67H TL	ME 888 Marathon Ultra WW	Cruising	FRONT	2407600	7	-3.00-	2.50-3.50	147	656	335	1933	307	210	ME-F16*; ME F15/16**	
	130/90 - 16 M/C 67H TL	Roadtec 01	Sport Touring	FRONT	3555200	7	-3.00-	2.50-3.50	147	656	335	1933	307	210	ME-F16*; ME F15/16**	
	130/90 - 16 M/C 67S TL	Perfect ME 77	Classic	REAR	0129900	7	-3.00-	2.50-3.50	147	656	332	1933	307	180	ME K 16	
	130/90 - 16 M/C 67V TL	Roadtec 01	Sport Touring	REAR	3241800	3/7/8	-3.00-	2.50-3.50	147	656	339	1933	307	240	ME-F16*; ME F15/16**	
	130/90 B 16 M/C 73H reinf TL	Cruisetec	Cruising	REAR	3576800	7	-3.00-	2.50-3.50	147	656	335	1933	365	210	ME-F16*; ME F15/16**	
	130/90 B 16 M/C 73H reinf TL	Cruisetec	Cruising	FRONT	3576400	7	-3.00-	2.50-3.50	147	656	335	1933	365	210	ME-F16*; ME F15/16**	
	130/90 B 16 M/C 73H reinf TL	ME 888 Marathon Ultra	Cruising	REAR	2318500	7	-3.00-	2.50-3.50	147	656	335	1933	365	210	ME-F16*; ME F15/16**	
	130/90 B 16 M/C 73H reinf TL	ME 888 Marathon Ultra	Cruising	FRONT	2703600	7	-3.00-	2.50-3.50	147	656	335	1933	365	210	ME-F16*; ME F15/16**	
	130/90 B 16 M/C 73H reinf TL	ME 888 Marathon Ultra WW	Cruising	REAR	2408300	7	-3.00-	2.50-3.50	147	656	335	1933	365	210	ME-F16*; ME F15/16**	
	130/90 B 16 M/C 73H reinf TL	Perfect ME 77	Cruising	REAR	3139800	7	-3.00-	2.50-3.50	147	656	335	1933	365	210	ME-F16*; ME F15/16**	
	140/90 B 16 M/C 77H reinf TL	ME 888 Marathon Ultra	Cruising	REAR	2408800	7	-3.50-	2.75-3.75	159	676	345	1987	412	210	ME-F16*; ME F15/16**	
	140/90 B 16 M/C 77H reinf TL	ME 888 Marathon Ultra WW	Cruising	REAR	2408900	7	-3.50-	2.75-3.75	159	676	345	1987	412	210	ME-F16*; ME F15/16**	
	150/80 - 16 M/C 71H TL	Cruisetec	Cruising	FRONT	3576900	7	-3.50-	3.00-4.25	173	662	339	1951	345	210	ME-F16*; ME F15/16**	
	150/80 - 16 M/C 71H TL	ME 888 Marathon Ultra	Cruising	FRONT	2661600	7	-3.50-	3.00-4.25	173	662	339	1951	345	210	ME-F16*; ME F15/16**	
	150/80 - 16 M/C 71H TL	Roadtec 01	Sport Touring	REAR	3555300	7	-3.50-	3.00-4.25	173	662	339	1951	345	210	ME-F16*; ME F15/16**	
	150/80 B 16 M/C 77H reinf TL	Cruisetec	Cruising	REAR	3576500	7	-3.50-	3.00-4.25	173	662	339	1951	412	210	ME-F16*; ME F15/16**	
	150/80 B 16 M/C 77H reinf TL	ME 888 Marathon Ultra	Cruising	REAR	2318600	7	-3.50-	3.00-4.25	173	662	339	1951	412	210	ME-F16*; ME F15/16**	
	150/80 B 16 M/C 77H reinf TL	ME 888 Marathon Ultra OW	Cruising	REAR	3483700	7	-3.50-	3.00-4.25	173	662	339	1951	412	210	ME-F16*; ME F15/16**	
	150/80 B 16 M/C 77H reinf TL	ME 888 Marathon Ultra WW	Cruising	REAR	2408000	7	-3.50-	3.00-4.25	173	662	339	1951	412	210	ME-F16*; ME F15/16**	
	150/80 B 16 M/C 77H reinf TL	Perfect ME 77	Cruising	REAR	3139900	7	-3.50-	3.00-4.25	173	662	339	1951	412	210	ME-F16*; ME F15/16**	
	150/80 R 16 M/C 71V TL	ME 888 Marathon Ultra	Cruising	FRONT	2680600	3/7/8	-3.50-	3.50-4.25	168	662	335	1951	345	240	ME-F16*; ME F15/16**	
	150/80 VB 16 M/C V250 (71V) TL	Lasertec	Cruising	REAR	1533400	3/7/8	-3.50-	3.00-4.25	173	662	342	1951	345	250	ME-F16*; ME F15/16**	
	160/80 B 16 M/C 75H TL	ME 888 Marathon Ultra	Cruising	REAR	2616600	7	-3.75-	3.50-4.50	184	680	348	1999	387	210	ME-F16*; ME F15/16**	
	170/70 B 16 M/C 75H TL	ME 888 Marathon Ultra	Cruising	REAR	2531600	7	-4.50-	4.00-5.50	196	660	337	1945	387	210	-	
	180/60 R 16 M/C 74H TL	ME 888 Marathon Ultra	Cruising	REAR	2429500	7	-5.00-	5.00-5.50	199	638	322	1878	375	210	-	
	180/60 R 16 M/C 80H reinf. TL	Cruisetec	Cruising	REAR	3577700	7	-5.00-	5.00-5.50	199	638	322	1878	450	210	-	
	180/60 R 16 M/C 80H reinf. TL	ME 888 Marathon Ultra	Cruising	REAR	2634900	7	-5.00-	5.00-5.50	199	638	322	1878	450	210	-	
	180/60 R 16 M/C 80H reinf. TL	Cruisetec I	Cruising	REAR	3838700	7	-5.00-	5.00-5.50	199	638	322	1878	450	210	-	
	180/65 B 16 M/C 81H reinf TL	Cruisetec	Cruising	REAR	3576200	7	-5.00-	4.25-5.50	205	656	335	1933	462	210	-	
	180/65 B 16 M/C 81H reinf TL	ME 888 Marathon Ultra	Cruising	REAR	2318700	7	-5.00-	4.25-5.50	205	656	335	1933	462	210	-	
	180/65 B 16 M/C 81H reinf TL	ME 888 Marathon Ultra WW	Cruising	REAR	2408400	7	-5.00-	4.25-5.50	205	656	335	1933	462	210	-	
	180/70 B 16 M/C 77H TL	Cruisetec	Cruising	REAR	3577000	7	-5.00-	4.25-5.50	205	688	345	1987	412	210	-	
	180/70 R 16 M/C 77V TL	ME 888 Marathon Ultra	Cruising	REAR	2680900	3/7/8	-5.00-	5.00-5.50	199	676	342	1987	412	240	-	
	2.50 - 16 41P reinf.	Block C	Classic	F/R	1419400		-1.50-	1.35-1.60	75	554	278	1635	145	150	-	
	2.75 - 16 M/C 46P reinf	Block C	Classic	F/R	0109200		-1.85-	1.50-1.85	86	574	287	1697	170	150	-	
	200/55 R 16 M/C 77H TL	Cruisetec	Cruising	REAR	3578500	7	-6.25-	6.00-6.50	216	642	324	1891	412	210	-	
	200/60 R 16 M/C 79V TL	ME 888 Marathon Ultra	Cruising	REAR	2704000	3/7/8	-5.50-	5.50-6.25	222	662	335	1951	437	240	-	
	240/50 R 16 M/C 84V TL	ME 888 Marathon Ultra	Cruising	REAR	2681100	3/7/8	-7.50-	7.00-8.00	261	662	335	1951	500	240	-	

* Ventil 34G - SV ** Ventil 41,5G/86°

TECHNICAL DATA TO STANDARD/65

Category	Rim	Description	Pattern Set	Application	F/R	IP Code	Footnote	Measuring Rim width	Permitted Rim width range	Max width in service	Diameter in service	Centrifugal radius at V-Max (W=240 km/h)	Rolling Circumference +/- 2%	Load capacity (kg)	V-max	Tube	
On Road	16	3.25 - 16 M/C 55P reinf	Block C	Classic	F/R	0109500		-2.15-	1.85-2.50	106	600	300	1776	218	150	ME C/D16	
		3.50 - 16 M/C 58P reinf	Block C	Classic	F/R	0109600		-2.15-	1.85-2.50	111	612	306	1806	236	150	ME C/D16; ME E 16 (B)	
		4.60 - 16 M/C 59S TL	Perfect ME 77	Classic	REAR	0131000	7	-2.75-	2.15-3.00	139	619	312	1824	243	180	ME E 16 (B)	
		MT 90 B 16 M/C 72H TL	Cruisetec	Cruising	FRONT	3578000	7	-3.00-	2.50-3.50	149	672	341	1963	355	210	ME F 15/16**	
		MT 90 B 16 M/C 72H TL	ME 888 Marathon Ultra	Cruising	FRONT	2318100	7	-3.00-	2.50-3.50	149	672	341	1963	355	210	ME F 15/16**	
		MT 90 B 16 M/C 72H TL	ME 888 Marathon Ultra WW	Cruising	FRONT	2407500	7	-3.00-	2.50-3.50	149	672	341	1963	355	210	ME F 15/16**	
		MT 90 B 16 M/C 74H TL	Cruisetec	Cruising	REAR	3578300	7	-3.00-	2.50-3.50	149	672	341	1963	375	210	ME F 15/16**	
		MT 90 B 16 M/C 74H TL	ME 888 Marathon Ultra	Cruising	REAR	2318800	7	-3.00-	2.50-3.50	149	672	341	1963	375	210	ME F 15/16**	
		MT 90 B 16 M/C 74H TL	ME 888 Marathon Ultra WW	Cruising	REAR	2408200	7	-3.00-	2.50-3.50	149	672	341	1963	375	210	ME F 15/16**	
		MU 85 B 16 M/C 77H TL	Cruisetec	Cruising	REAR	3578100	7	-3.50-	3.00-3.50	158	681	345	1987	412	210	ME F 15/16**	
		MU 85 B 16 M/C 77H TL	ME 888 Marathon Ultra	Cruising	REAR	2318900	7	-3.50-	3.00-3.50	158	681	345	1987	412	210	ME F 15/16**	
		MU 85 B 16 M/C 77H TL	ME 888 Marathon Ultra WW	Cruising	REAR	2408100	7	-3.50-	3.00-3.50	158	681	345	1987	412	210	ME F 15/16**	
		17	100/80 - 17 M/C 52H TL	Sportec Street	Scooter	FRONT	2715700	7	-2.50-	2.15-2.75	114	604	304	1788	200	210	-
			100/80 - 17 M/C 52H TL	Roadtec 01	Sport Touring	FRONT	3241100	7	-2.50-	2.15-2.75	114	604	304	1788	200	210	-
			110/70 - 17 M/C 54H TL	Sportec Street	Scooter	FRONT	2715300	7	-3.00-	2.50-3.50	127	596	303	1770	212	210	ME E17
		110/70 - 17 M/C 54H TL	Roadtec 01	Sport Touring	FRONT	3132400	7	-3.00-	2.50-3.50	127	596	303	1770	212	210	ME E17	
		110/70 R 17 M/C 54H TL	Sportec M9 RR	Sport	FRONT	3627200	7	-3.00-	3.00-3.50	123	596	301	1770	212	210	ME E17	
		110/70 ZR 17 M/C 54W TL	Sportec M7 RR	Sport	FRONT	2449800	4/7/8	-3.00-	3.00-3.50	123	596	301	1770	212	270	ME E17	
		110/70 ZR 17 M/C 54W TL	Sportec M9 RR	Sport	FRONT	3626600	4/7/8	-3.00-	3.00-3.50	123	596	301	1770	212	270	ME E17	
		110/70 ZR 17 M/C 54W TL	Roadtec Z8 Interact M	Sport Touring	FRONT	2491300	4/7/8	-3.00-	3.00-3.50	123	596	301	1770	212	270	ME E17	
		110/80 - 17 M/C 57H TL	Roadtec 01	Sport Touring	FRONT	3241200	7	-2.50-	2.15-3.00	125	620	315	1836	230	210	ME E17	
		120/60 ZR 17 M/C (55W) TL	Sportec M7 RR	Sport	FRONT	2449900	4/7/8	-3.50-	3.00-3.75	134	586	295	1740	218	280	ME E17	
		120/60 ZR 17 M/C (55W) TL	Roadtec 01	Sport Touring	FRONT	2669900	4/7/8	-3.50-	3.00-3.75	134	586	295	1740	218	280	ME E17	
		120/60 ZR 17 M/C (55W) TL	Roadtec Z8 Interact M	Sport Touring	FRONT	2491200	4/7/8	-3.50-	3.00-3.75	134	586	295	1740	218	280	ME E17	
		120/70 - 17 M/C 58S TL	Sportec Street	Scooter	F/R	2761600	7	-3.50-	2.75-3.75	137	612	314	1812	236	180	ME E17	
		120/70 - 17 M/C 58V TL	Lasertec	Cruising	FRONT	1531200	3/7/8	-3.50-	3.00-3.75	137	612	314	1812	236	240	ME E17	
		120/70 B 17 M/C 58V TL	ME 888 Marathon Ultra	Cruising	FRONT	2703200	3/7/8	-3.50-	3.00-3.75	137	612	314	1812	236	240	ME E17	
		120/70 ZR 17 M/C (58W) TL	Racetec RR K1	Racing	FRONT	2548300	4/7/8	-3.50-	3.50-3.75	133	612	308	1812	236	280	ME E17	
		120/70 ZR 17 M/C (58W) TL	Racetec RR K2	Racing	FRONT	2548400	4/7/8	-3.50-	3.50-3.75	133	612	308	1812	236	280	ME E17	
		120/70 ZR 17 M/C (58W) TL	Racetec RR K3	Racing	FRONT	2525700	4/7/8	-3.50-	3.50-3.75	133	612	308	1812	236	320	ME E17	
		120/70 ZR 17 M/C (58W) TL	Sportec M5 Interact	Sport	FRONT	1927400	4/7/8	-3.50-	3.50-3.75	133	612	308	1812	236	320	ME E17	
		120/70 ZR 17 M/C (58W) TL	Sportec M7 RR M	Sport	FRONT	2520800	4/7/8	-3.50-	3.50-3.75	133	612	308	1812	236	320	ME E17	
		120/70 ZR 17 M/C (58W) TL	Sportec M9 RR	Sport	FRONT	3616900	4/7/8	-3.50-	3.50-3.75	133	612	308	1812	236	320	ME E17	
		120/70 ZR 17 M/C (58W) TL	Roadtec 01 E	Sport Touring	FRONT	3803500	4/7/8	-3.50-	3.50-3.75	133	612	308	1812	236	320	ME E17	
		120/70 ZR 17 M/C (58W) TL	Roadtec 01 SE	Sport Touring	FRONT	3850800	4/7/8	-3.50-	3.50-3.75	133	612	308	1812	236	320	ME E17	
		120/70 ZR 17 M/C (58W) TL	Roadtec Z6	Sport Touring	FRONT	1448100	4/7/8	-3.50-	3.50-3.75	133	612	308	1812	236	300	ME E17	
		120/70 ZR 17 M/C (58W) TL	Roadtec Z8 Interact M	Sport Touring	FRONT	2283600	4/7/8	-3.50-	3.50-3.75	133	612	308	1812	236	320	ME E17	
		120/70 ZR 17 M/C (58W) TL	Roadtec 01 HWM	Sport Touring	FRONT	2681200	4/7/8	-3.50-	3.50-3.75	133	612	308	1812	236	320	ME E17	
		120/90 - 17 M/C 64S TT	ME 888 Marathon Ultra	Cruising	FRONT	3133100		-2.75-	2.50-3.00	134	664	335	1957	280	180	ME E17; ME F 17 (B)	
		130/70 - 17 M/C 62H TL	Sportec Street	Scooter	REAR	2715400	7	-3.50-	3.00-4.00	147	626	319	1854	265	210	ME E17; ME F 17 (B)	
		130/70 - 17 M/C 62H TL	Roadtec 01	Sport Touring	REAR	3132600	7	-3.50-	3.00-4.00	147	626	319	1854	265	210	ME E17; ME F 17 (B)	
		130/70 R 17 M/C 62V TL	ME 888 Marathon Ultra	Cruising	FRONT	3133200	3/7/8	-3.50-	3.50-4.00	143	626	316	1854	265	240	ME E17; ME F 17 (B)	
		130/80 - 17 M/C 65H TL	Roadtec 01	Sport Touring	REAR	3241900	7	-3.00-	2.50-3.50	147	654	334	1933	290	210	ME F17 (B)	
		130/80 B 17 M/C 65H TL	Cruisetec	Cruising	FRONT	3576100	7	-3.00-	2.50-3.50	147	654	334	1933	290	210	ME F17 (B)	
		130/80 B 17 M/C 65H TL	ME 888 Marathon Ultra Fr.	Cruising	FRONT	2318200	7	-3.00-	2.50-3.50	147	654	334	1933	290	210	ME F17 (B)	
		130/80 B 17 M/C 65H TL	ME 888 Marathon Ultra WW	Cruising	FRONT	2407700	7	-3.00-	2.50-3.50	147	654	334	1933	290	210	ME F17 (B)	
		130/80 B 17 M/C 65H TL	Cruisetec I	Cruising	FRONT	3950900	7	-3.00-	2.50-3.50	147	654	334	1933	290	210	ME F17 (B)	
		140/70 - 17 M/C 66H TL	Sportec Street	Scooter	REAR	2715500	7	-3.75-	3.50-4.50	162	642	327	1897	300	210	ME K17	
		140/70 - 17 M/C 66H TL	Roadtec 01	Sport Touring	REAR	3242100	7	-3.75-	3.50-4.50	162	642	327	1897	300	210	ME K17	
		140/70 R 17 M/C 66H TL	Sportec M9 RR	Sport	REAR	3627300	7	-3.75-	3.75-4.50	157	642	324	1897	300	210	ME K17	
		140/75 R 17 M/C 67V TL	ME 888 Marathon Ultra	Cruising	FRONT	3133300	3/7/8	-3.50-	3.50-4.25	154	656	332	1939	307	240	-	
		140/80 - 17 M/C 69H TL	ME 888 Marathon Ultra	Cruising	FRONT	2703500	7	-3.50-	2.75-3.75	159	672	343	1981	325	210	ME K17	
		140/80 - 17 M/C 69V TL	Roadtec 01	Sport Touring	REAR	3242200	3/7/8	-3.50-	2.75-3.75	159	672	346	1981	325	240	ME K17	
		140/80 B 17 M/C 69V TL	ME 888 Marathon Ultra	Cruising	REAR	3134600	3/7/8	-3.50-	2.75-3.75	159	672	346	1981	325	240	ME K17	
		150/60 - 17 M/C 66H TL	Sportec Street	Scooter	REAR	2715800	7	-4.25-	3.50-4.50	164	624	315	1848	300	210	ME K17	
		150/60 R 17 M/C 66H TL	Sportec M9 RR	Sport	REAR	3627400	7	-4.25-	4.00-4.50	164	624	315	1848	300	210	ME K17	
		150/60 ZR 17 M/C 66W TL	Sportec M7 RR	Sport	REAR	2450100	4/7/8	-4.25-	4.00-4.50	164	624	315	1848	300	270	ME K17	
		150/60 ZR 17 M/C 66W TL	Sportec M9 RR	Sport	REAR	3626700	4/7/8	-4.25-	4.00-4.50	164	624	315	1848	300	270	ME K17	
		150/70 - 17 M/C 69H TL	Lasertec	Cruising	REAR	1533500	7	-4.25-	3.50-4.50	169	656	335	1939	325	210	ME K17	
		150/70 - 17 M/C 69H TL	Roadtec 01	Sport Touring	REAR	3242300	7	-4.25-	3.50-4.50	169	656	335	1939	325	210	ME K17	
		150/70 - 17 M/C 69V TL	Roadtec 01	Sport Touring	REAR	3242400	3/7/8	-4.25-	3.50-4.50	169	656	338	1939	325	240	ME K17	

66 / TECHNICAL DATA TO STANDARD

Category	Rim	Description	Pattern Set	Application	F/R	IP Code	Footnotes	Measuring Rim width	Permitted Rim width range	Max width in service	Diameter in service	Centrifugal radius at V-Max (V=240 km/h)	Rolling Circumference +/- 2%	Load capacity (kg)	V-max	Tube
On Road	17	150/70 R 17 M/C 69V TL	Roadtec 01	Sport Touring	REAR	2670600	3/7/8	-4.25-	4.00-4.50	165	656	332	1939	325	240	ME K17
	150/70 VB 17 M/C (69V) TL	Lasertec	Cruising	REAR	1533700	3/7/8	-4.25-	3.50-4.50	169	656	338	1939	325	250	ME K17	
	150/70 ZR 17 M/C (69W) TL	Roadtec Z8 Interact M	Sport Touring	REAR	2491700	4/7/8	-4.25-	4.00-4.50	165	656	332	1939	325	280	ME K17	
	150/80 R 17 M/C 72V TL	ME 888 Marathon Ultra	Cruising	FRONT	2680800	3/7/8	-3.50-	3.50-4.25	169	688	348	2029	355	240	ME K17	
	160/60 ZR 17 M/C (69W) TL	Racetec RR K2	Racing	REAR	2548500	4/7/8	-4.50-	4.25-5.00	178	638	322	1884	325	280	ME K17	
	160/60 ZR 17 M/C (69W) TL	Racetec RR K3	Racing	REAR	2525800	4/7/8	-4.50-	4.25-5.00	178	638	322	1884	325	290	ME K17	
	160/60 ZR 17 M/C (69W) TL	Sportec M9 RR	Sport	REAR	3617000	4/7/8	-4.50-	4.25-5.00	178	638	322	1884	325	280	ME K17	
	160/60 ZR 17 M/C (69W) TL	Sportec M5 Interact	Sport	REAR	1971300	4/7/8	-4.50-	4.25-5.00	178	638	322	1884	325	280	ME K17	
	160/60 ZR 17 M/C (69W) TL	Sportec M7 RR	Sport	REAR	2450200	4/7/8	-4.50-	4.25-5.00	178	638	322	1884	325	280	ME K17	
	160/60 ZR 17 M/C (69W) TL	Roadtec 01 SE	Sport Touring	REAR	3850900	4/7/8	-4.50-	4.25-5.00	178	638	322	1884	325	280	ME K17	
	160/60 ZR 17 M/C (69W) TL	Roadtec Z6	Sport Touring	REAR	1448700	4/7/8	-4.50-	4.25-5.00	178	638	322	1884	325	280	ME K17	
	160/60 ZR 17 M/C (69W) TL	Roadtec Z8 Interact M	Sport Touring	REAR	2491600	4/7/8	-4.50-	4.25-5.00	178	638	322	1884	325	280	ME K17	
	160/70 B 17 M/C 73V TL	Lasertec	Cruising	REAR	1533800	3/7/8	-4.50-	3.75-5.00	183	672	346	1981	365	240	ME G17	
	160/70 B 17 M/C 79V reinf. TL	Cruisetec	Cruising	REAR	3576700	3/7/8	-4.50-	3.75-5.00	183	672	346	1981	437	240	ME G17	
	160/70 B 17 M/C 79V reinf. TL	ME 888 Marathon Ultra	Cruising	REAR	2409000	3/7/8	-4.50-	3.75-5.00	183	672	346	1981	437	240	ME G17	
	160/70 ZR 17 M/C 73W TL	Roadtec 01	Sport Touring	REAR	4016900	4/7/8	-4.50-	4.25-5.00	178	672	339	1981	365	270	ME G17	
	170/60 R 17 M/C 72V TL	Sportec M9 RR	Sport	REAR	3617600	3/7/8	-4.50-	4.50-5.50	190	650	328	1921	355	240	ME G17	
	170/60 R 17 M/C 78V reinf. TL	ME 888 Marathon Ultra	Cruising	REAR	3134700	3/7/8	-4.50-	4.50-5.50	190	650	328	1921	425	240	ME G17	
	170/60 ZR 17 M/C (72W) TL	Roadtec Z6	Sport Touring	REAR	1449100	4/7/8	-4.50-	4.50-5.50	190	650	328	1921	355	290	ME G17	
	170/60 ZR 17 M/C (72W) TL	Roadtec Z8 Interact M	Sport Touring	REAR	2491900	4/7/8	-4.50-	4.50-5.50	190	650	328	1921	355	290	ME G17	
	170/60 ZR 17 M/C (72W) TL	Roadtec 01	Sport Touring	REAR	2670700	4/7/8	-4.50-	4.50-5.50	190	650	328	1921	355	270	ME G17	
	180/55 ZR 17 M/C (73W) TL	Racetec RR K2	Racing	REAR	2548600	4/7/8	-5.50-	5.50-6.00	196	644	325	1903	365	280	ME G17	
	180/55 ZR 17 M/C (73W) TL	Racetec RR K3	Racing	REAR	2525900	4/7/8	-5.50-	5.50-6.00	196	644	325	1903	365	300	ME G17	
	180/55 ZR 17 M/C (73W) TL	Sportec M5 Interact	Sport	REAR	1927600	4/7/8	-5.50-	5.50-6.00	196	644	325	1910	365	300	ME G17	
	180/55 ZR 17 M/C (73W) TL	Sportec M7 RR	Sport	REAR	2450300	4/7/8	-5.50-	5.50-6.00	196	644	325	1910	365	300	ME G17	
	180/55 ZR 17 M/C (73W) TL	Sportec M9 RR	Sport	REAR	3617100	4/7/8	-5.50-	5.50-6.00	196	644	325	1910	365	300	ME G17	
	180/55 ZR 17 M/C (73W) TL	Roadtec 01 HWM	Sport Touring	REAR	2681300	4/7/8	-5.50-	5.50-6.00	196	644	325	1903	365	300	ME G17	
	180/55 ZR 17 M/C (73W) TL	Roadtec 01 SE	Sport Touring	REAR	3851000	4/7/8	-5.50-	5.50-6.00	196	644	325	1903	365	300	ME G17	
	180/55 ZR 17 M/C (73W) TL	Roadtec Z6	Sport Touring	REAR	1448600	4/7/8	-5.50-	5.50-6.00	196	644	325	1903	365	300	ME G17	
	180/55 ZR 17 M/C (73W) TL	Roadtec Z8 Interact K	Sport Touring	REAR	2426800	4/7/8	-5.50-	5.50-6.00	196	644	325	1903	365	280	ME G17	
	180/55 ZR 17 M/C (73W) TL	Roadtec Z8 Interact M	Sport Touring	REAR	2283700	4/7/8	-5.50-	5.50-6.00	196	644	325	1903	365	300	ME G17	
	180/55 ZR 17 M/C (73W) TL	Roadtec Z8 Interact O	Sport Touring	REAR	2283800	4/7/8	-5.50-	5.50-6.00	196	644	325	1903	365	300	ME G17	
	180/55 ZR 17 M/C (73W) TL	Roadtec 01 E	Sport Touring	REAR	3562700	4/7/8	-5.50-	5.50-6.00	196	644	325	1903	365	300	ME G17	
	180/60 B 17 M/C 75V TL	ME 888 Marathon Ultra	Cruising	REAR	2703300	3/7/8	-5.00-	4.25-5.50	205	664	341	1957	387	240	-	
	180/60 ZR 17 M/C (75W) TL	Racetec RR K1	Racing	REAR	2548700	4/7/8	-5.00-	5.00-5.50	199	664	335	1957	387	280	-	
	180/60 ZR 17 M/C (75W) TL	Racetec RR K2	Racing	REAR	2548800	4/7/8	-5.00-	5.00-5.50	199	664	335	1957	387	280	-	
	180/60 ZR 17 M/C (75W) TL	Sportec M9 RR	Sport	REAR	3626800	4/7/8	-5.00-	5.00-5.50	199	664	335	1957	387	300	-	
	190/50 ZR 17 M/C (73W) TL	Racetec RR K3	Racing	REAR	2526000	4/7/8	-6.00-	5.50-6.00	203	636	321	1878	365	320	ME G17	
	190/50 ZR 17 M/C (73W) TL	Sportec M7 RR	Sport	REAR	2450400	4/7/8	-6.00-	5.50-6.00	203	636	321	1878	365	320	ME G17	
	190/50 ZR 17 M/C (73W) TL	Sportec M9 RR	Sport	REAR	3617200	4/7/8	-6.00-	5.50-6.00	203	636	321	1878	365	320	ME G17	
	190/50 ZR 17 M/C (73W) TL	Roadtec 01 HWM	Sport Touring	REAR	2681400	4/7/8	-6.00-	5.50-6.00	203	636	321	1878	365	320	ME G17	
	190/50 ZR 17 M/C (73W) TL	Roadtec 01 SE	Sport Touring	REAR	3851200	4/7/8	-6.00-	5.50-6.00	203	636	321	1878	365	320	ME G17	
	190/50 ZR 17 M/C (73W) TL	Roadtec Z6	Sport Touring	REAR	1449000	4/7/8	-6.00-	5.50-6.00	203	636	321	1878	365	300	ME G17	
	190/50 ZR 17 M/C (73W) TL	Roadtec Z8 Interact M	Sport Touring	REAR	2283900	4/7/8	-6.00-	5.50-6.00	203	636	321	1878	365	300	ME G17	
	190/50 ZR 17 M/C (73W) TL	Roadtec Z8 Interact O	Sport Touring	REAR	2284000	4/7/8	-6.00-	5.50-6.00	203	636	321	1878	365	300	ME G17	
	190/55 ZR 17 M/C (75W) TL	Racetec RR K1	Racing	REAR	3888100	4/7/8	-6.00-	5.50-6.00	203	656	332	1939	387	320	-	
	190/55 ZR 17 M/C (75W) TL	Racetec RR K2	Racing	REAR	3888200	4/7/8	-6.00-	5.50-6.00	203	656	332	1939	387	320	-	
	190/55 ZR 17 M/C (75W) TL	Racetec RR K3	Racing	REAR	2526100	4/7/8	-6.00-	5.50-6.00	203	656	332	1939	387	320	-	
	190/55 ZR 17 M/C (75W) TL	Sportec M7 RR	Sport	REAR	2450500	4/7/8	-6.00-	5.50-6.00	203	656	332	1939	387	320	-	
	190/55 ZR 17 M/C (75W) TL	Sportec M9 RR	Sport	REAR	3617300	4/7/8	-6.00-	5.50-6.00	203	656	332	1939	387	320	-	
	190/55 ZR 17 M/C (75W) TL	Roadtec 01 HWM	Sport Touring	REAR	2681500	4/7/8	-6.00-	5.50-6.00	203	656	332	1939	387	320	-	
	190/55 ZR 17 M/C (75W) TL	Roadtec 01 SE	Sport Touring	REAR	3851300	4/7/8	-6.00-	5.50-6.00	203	656	332	1939	387	320	-	
	190/55 ZR 17 M/C (75W) TL	Roadtec Z8 Interact M	Sport Touring	REAR	2284100	4/7/8	-6.00-	5.50-6.00	203	656	332	1939	387	320	-	
	190/55 ZR 17 M/C (75W) TL	Roadtec Z8 Interact O	Sport Touring	REAR	2284200	4/7/8	-6.00-	5.50-6.00	203	656	332	1939	387	320	-	
2.50 - 17 M/C 43P reinf	ME 22	Classic	F/R	2704400		-1.50-	1.35-1.60	75	580	290	1715	155	150	ME C/D 17		
2.75 - 17 M/C 47P reinf	ME 22	Classic	F/R	2704500		-1.85-	1.50-1.85	86	600	300	1776	175	150	ME C/D 17		
200/50 ZR 17 M/C 75W TL	ME 888 Marathon Ultra	Cruising	REAR	2681000	4/7/8	-6.25-	6.00-6.50	217	646	326	1919	387	270	ME G17		
200/55 R 17 M/C 78V TL	Cruisetec	Cruising	REAR	3577900	3/7/8	-6.25-	6.00-6.50	216	668	337	1969	425	240	-		
200/55 R 17 M/C 78V TL	ME 888 Marathon Ultra	Cruising	REAR	2703900	3/7/8	-6.25-	6.00-6.50	216	668	337	1969	425	240	-		
200/55 ZR 17 M/C (78W) TL	Racetec RR K1	Racing	REAR	3888300	4/7/8	-6.25-	6.00-6.50	216	668	337	1969	425	280	-		
200/55 ZR 17 M/C (78W) TL	Racetec RR K2	Racing	REAR	3888400	4/7/8	-6.25-	6.00-6.50	216	668	337	1969	425	280	-		

TECHNICAL DATA TO STANDARD/67

Category	Rim	Description	Pattern Set	Application	F/R	IP Code	Footnotes	Measuring Rim width	Permitted Rim width range	Max width in service	Diameter in service	Centrifugal radius at V-Max (V=240 km/h)	Rolling Circumference +/- 2%	Load capacity (kg)	V-max	Tube
17	200/55 ZR 17 M/C (78W) TL	Racetec RR K3	Racing	REAR	3888500	4/7/8	-6.25-	6.00-6.50	216	668	337	1969	425	320	-	
	200/55 ZR 17 M/C (78W) TR	Sportec M9 RR	Sport	REAR	3617400	4/7/8	-6.25-	6.00-6.50	216	668	337	1969	425	320	-	
	210/50 ZR 17 M/C (78W) TL	ME 888 Marathon Ultra	Cruising	REAR	3134800	4/7/8	-6.50-	6.25-7.00	229	656	332	1939	425	280	ME G17	
	3.00 - 17 M/C 50P reinf	ME 22	Classic	F/R	0116100		-1.85-	1.60-2.15	95	614	307	1818	190	150	ME C/D 17	
	60/100 - 17 M/C 33L	ME 22	Classic	FRONT	1713400		-1.40-	1.20-1.60	68	560	282	1667	115	120	-	
	70/90 - 17 M/C 38 S TL	Sportec Street	Scooter	F/R	2903700	7	-1.60-	1.40-1.85	79	566	285	1685	132	180	-	
	80/90 - 17 M/C 44 S TL	Sportec Street	Scooter	F/R	2903800	7	-1.85-	1.60-2.15	91	586	295	1740	160	180	-	
	90/80 - 17 M/C 46 S TL	Sportec Street	Scooter	F/R	2903900	7	-2.15-	1.85-2.50	103	586	295	1740	170	180	-	
	18	100/90 - 18 M/C 56H TL	ME 888 Marathon Ultra	Cruising	FRONT	2703700	7	-2.50-	2.15-2.75	114	649	331	1924	224	210	ME E18
100/90 - 18 M/C 56H TR		Roadtec 01	Sport Touring	FRONT	3241400	7	-2.50-	2.15-2.75	114	649	331	1924	224	210	ME E18	
100/90 - 18 M/C 56V TL		Roadtec 01	Sport Touring	FRONT	3241500	3/7/8	-2.50-	2.15-2.75	114	649	333	1924	224	240	ME E18	
100/90 V 18 M/C (56V) TL		Lasertec	Cruising	FRONT	1534500	3/7/8	-2.50-	2.15-2.75	114	649	333	1924	224	250	ME E18	
110/80 - 18 M/C 58H TL		Lasertec	Cruising	FRONT	1530500	7	-2.50-	2.15-3.00	125	645	328	1912	236	210	ME E18	
110/80 V 18 M/C (58V) TL		Lasertec	Cruising	FRONT	1534800	3/7/8	-2.50-	2.15-3.00	125	645	331	1912	236	260	ME E18	
110/80 ZR 18 M/C (58W) TL		Racetec RR K1	Racing	FRONT	2854500	4/7/8	-2.50-	2.50-3.00	122	645	326	1912	236	280	ME E18	
110/80 ZR 18 M/C (58W) TR		Roadtec Z8 Interact M	Sport Touring	FRONT	2491500	4/7/8	-2.50-	2.50-3.00	122	645	326	1912	236	280	ME E18	
110/90 - 18 M/C 61H TL		Lasertec	Cruising	REAR	1531900	7	-2.50-	2.15-3.00	125	669	341	1978	257	210	ME E18	
110/90 - 18 M/C 61H TR		ME 888 Marathon Ultra	Cruising	FRONT	2703800	7	-2.50-	2.15-3.00	125	669	341	1978	257	210	ME E18	
110/90 - 18 M/C 61H TL		Roadtec 01	Sport Touring	REAR	3242500	7	-2.50-	2.15-3.00	125	669	341	1978	257	210	ME E18	
110/90 - 18 M/C 61S		Perfect ME 77	Classic	REAR	1253100		-2.50-	2.15-3.00	125	669	338	1978	257	180	ME E 18	
120/70 ZR 18 M/C (59W) TL		ME 888 Marathon Ultra	Cruising	FRONT	3133600	4/7/8	-3.50-	3.50-3.75	134	637	321	1888	243	300	ME E18	
120/70 ZR 18 M/C (59W) TR		Roadtec Z8 Interact M	Sport Touring	FRONT	2491400	4/7/8	-3.50-	3.50-3.75	134	637	321	1888	243	300	ME E18	
120/80 - 18 M/C 62 H TL		Lasertec	Cruising	REAR	1532000	7	-2.75-	2.50-3.00	134	663	337	1960	265	210	ME F18	
120/80 - 18 M/C 62 H TR		Roadtec 01	Sport Touring	REAR	3242600	7	-2.75-	2.50-3.00	134	663	337	1960	265	210	ME F18	
130/60 VR 18 M/C (60V) TL		ME 888 Marathon Ultra	Cruising	FRONT	3133800	3/7/8	-3.50-	3.50-4.00	143	623	315	1851	250	260	ME E18	
130/70 - 18 M/C 63H TL		Lasertec	Cruising	REAR	1533000	7	-3.50-	3.00-4.00	147	651	332	1930	272	210	ME E18	
130/70 B 18 M/C 63H TL		Cruisetec	Cruising	FRONT	3974500	7	-3.50-	3.00-4.00	147	651	332	1930	272	210	ME E18	
130/70 B 18 M/C 63H TR		ME 888 Marathon Ultra	Cruising	FRONT	2531500	7	-3.50-	3.00-4.00	147	651	332	1930	272	210	ME E18	
130/70 R 18 M/C 63H TL		Cruisetec	Cruising	FRONT	3578400	7	-3.50-	3.50-4.00	143	651	329	1930	272	210	ME E18	
130/70 R 18 M/C 63H TR		ME 888 Marathon Ultra	Cruising	FRONT	2429400	7	-3.50-	3.50-4.00	143	651	329	1930	272	210	ME E18	
130/70 R 18 M/C 63V TL		ME 888 Marathon Ultra	Cruising	FRONT	3133900	3/7/8	-3.50-	3.50-4.00	143	651	329	1930	272	240	ME E18	
130/80 V 18 M/C (66V) TL		Lasertec	Cruising	REAR	1533100	3/7/8	-3.00-	2.50-3.50	147	679	350	2008	300	250	ME F18	
130/80 ZR 18 M/C (66V) TL		Racetec RR K1	Racing	REAR	3427600	3/7/8	-3.00-	3.00-3.50	143	679	343	2008	300	280	ME F18	
140/70 B 18 M/C 73 H reinf. TL		ME 888 Marathon Ultra	Cruising	FRONT	3134300	7	-3.75-	3.50-4.50	162	667	340	1972	365	210	ME F18	
140/70 ZR 18 M/C (67W) TL		Roadtec Z8 Interact M	Sport Touring	REAR	2415800	4/7/8	-3.75-	3.75-4.50	157	667	337	1972	307	280	ME F18	
150/65 ZR 18 M/C (69W) TL		Racetec RR K1	Racing	REAR	3272300	4/7/8	-4.25-	4.00-4.50	165	667	337	1972	325	280	-	
150/70 B 18 M/C 76H reinf. TL		Cruisetec	Cruising	REAR	3578200	7	-4.25-	3.50-4.50	169	681	348	2014	400	210	ME F18	
150/70 B 18 M/C 76H reinf. TR		ME 888 Marathon Ultra	Cruising	REAR	2616700	7	-4.25-	3.50-4.50	169	681	348	2014	400	210	ME F18	
160/60 R 18 M/C 70V TL		Cruisetec	Cruising	FRONT	3797200	3/7/8	-4.50-	4.25-5.00	178	663	335	1960	335	240	ME G18	
160/60 R 18 M/C 76V reinf. TL		ME 888 Marathon Ultra	Cruising	REAR	3134900	3/7/8	-4.50-	4.25-5.00	178	663	335	1960	400	240	ME G18	
160/60 ZR 18 M/C (70W) TL		Racetec RR K1	Racing	REAR	2854600	4/7/8	-4.50-	4.25-5.00	179	663	335	1960	335	280	ME G18	
160/60 ZR 18 M/C (70W) TR		Roadtec Z6	Sport Touring	REAR	1448900	4/7/8	-4.50-	4.25-5.00	179	663	335	1960	335	280	ME G18	
160/60 ZR 18 M/C (70W) TR		Roadtec Z8 Interact M	Sport Touring	REAR	2491800	4/7/8	-4.50-	4.25-5.00	179	663	335	1960	335	280	ME G18	
180/55 B 18 M/C 80H reinf. TL		Cruisetec	Cruising	REAR	3577100	7	-5.50-	5.50-6.00	201	669	341	1978	450	210	ME G18	
180/55 B 18 M/C 80H reinf. TR		ME 888 Marathon Ultra	Cruising	REAR	2634700	7	-5.50-	5.50-6.00	201	669	341	1978	450	210	ME G18	
180/55 ZR 18 M/C (74W) TL		Cruisetec	Cruising	REAR	3577500	4/7/8	-5.50-	5.50-6.00	195	669	338	1978	375	280	ME G18	
180/55 ZR 18 M/C (74W) TR		ME 888 Marathon Ultra	Cruising	REAR	2704200	4/7/8	-5.50-	5.50-6.00	195	669	338	1978	375	280	ME G18	
2.75 - 18 M/C 48P reinf. TL		ME 22	Classic	F/R	1546300	7	-1.85-	1.50-1.85	86	625	313	1851	180	150	ME C18	
200/50 R 18 M/C 82H reinf. TL		ME 888 Marathon Ultra	Cruising	REAR	2703400	7	-6.25-	6.00-6.50	216	671	339	1984	475	210	-	
210/40 R 18 M/C 73H TL		ME 888 Marathon Ultra	Cruising	REAR	3135100	7	-7.50-	7.00-8.00	231	637	321	1888	365	210	-	
240/40 VR 18 M/C (79V) TL	Cruisetec	Cruising	REAR	3577400	3/7/8	-8.50-	8.00-9.00	262	663	335	1960	437	260	ME K18		
240/40 VR 18 M/C (79V) TR	ME 888 Marathon Ultra	Cruising	REAR	2704100	3/7/8	-8.50-	8.00-9.00	262	663	335	1960	437	260	ME K18		
260/40 VR 18 M/C (84V) TL	Cruisetec	Cruising	REAR	3656900	3/7/8	-9.00-	8.50-9.50	281	679	343	2008	500	260	-		
260/40 VR 18 M/C (84V) TR	ME 888 Marathon Ultra	Cruising	REAR	2781500	3/7/8	-9.00-	8.50-9.50	281	679	343	2008	500	260	-		
280/35 VR 18 M/C (84V) TL	ME 888 Marathon Ultra	Cruising	REAR	3135200	3/7/8	-10.00-	9.50-10.50	306	667	337	1972	500	260	ME K18		
3.00 - 18 M/C 47S TL	Perfect ME 77	Classic	F/R	1204700	7	-1.85-	1.60-2.15	95	639	323	1894	175	180	ME D18		
3.00 - 18 M/C 52P reinf TL	ME 22	Classic	F/R	3609800	7	-1.85-	1.60-2.15	95	639	320	1894	200	150	ME D18		
3.25 - 18 52S	Block C	Classic	F/R	0712800		-2.15-	1.85-2.50	106	651	329	1930	200	180	ME E18		
3.25 - 18 M/C 52H	ME 11	Classic	FRONT	0111700		-2.15-	1.85-2.50	106	651	332	1930	200	210	ME E18		
3.25 - 18 M/C 59P reinf	ME 22	Classic	F/R	0113700		-2.15-	1.85-2.50	106	651	326	1930	243	150	ME E18		

68/ TECHNICAL DATA TO STANDARD

Category	Rim	Description	Pattern Set	Application	F/R	IP Code	Footnotes	Measuring Rim width	Permitted Rim width range	Max width in service	Diameter in service	Centrifugal radius at V-Max (V=240 km/h)	Rolling Circumference +/- 2%	Load capacity (kg)	V-max	Tube	
On Road	18	3.50 - 18 56S TL	Perfect ME 77	Classic	FRONT	0130400	7	-2.15-	1.85-2.50	111	663	335	1960	224	180	ME E18	
		3.50 - 18 M/C 56S	Block C	Classic	F/R	0932300		-2.15-	1.85-2.50	111	663	335	1960	224	180	ME E18	
		3.50 - 18 M/C 56S	Perfect ME 77	Classic	REAR	0130500		-2.15-	1.85-2.50	111	663	335	1960	224	180	ME E18	
		3.50 - 18 M/C 62P reinf	ME 22	Classic	F/R	3609900		-2.15-	1.85-2.50	111	663	332	1960	265	150	ME E18	
		300/35 VR 18 M/C (87V) TL	ME 888 Marathon Ultra	Cruising	REAR	3135300	3/7/8	-10.50-	10.00-11.00	325	681	345	2014	545	260	ME K18	
		4.00 - 18 64H	Block C Touring Special	Classic	F/R	0110100		-2.50-	1.85-3.00	122	685	350	2026	280	210	ME F18	
		4.00 - 18 64P	Block K	Classic	F/R	0109700		-2.50-	1.85-3.00	122	685	344	2026	280	150	ME F18	
		4.00 - 18 M/C 64H TL	Perfect ME 77	Classic	REAR	0131800	7	-2.50-	1.85-3.00	122	685	350	2026	280	210	ME F18	
		4.00 - 18 M/C 64V TL	Lasertec	Cruising	REAR	1533900	3/7/8	-2.50-	1.85-3.00	122	685	353	2026	280	240	ME F18	
		4.00 - 18 M/C 64V TL	Roadtec 01	Sport Touring	REAR	3242800	3/7/8	-2.50-	1.85-3.00	122	685	353	2026	280	240	ME F18	
		4.10 - 18 M/C 60H TL	Perfect ME 77	Classic	REAR	0132000	7	-2.50-	1.85-3.00	122	651	332	1930	250	210	ME E18	
		90/100 - 18 M/C 54S	Perfect ME 77	Classic	FRONT	1253000		-2.15-	1.85-2.50	102	649	328	1924	212	180	-	
		90/90 - 18 M/C 51H TL	Lasertec	Cruising	FRONT	1531700	7	-2.15-	1.85-2.50	103	631	321	1869	195	210	ME D18	
		90/90 - 18 M/C 51P TL	Roadtec 01	Sport Touring	REAR	3776000	7	-2.15-	1.85-2.50	103	631	321	1869	195	210	ME D18	
		90/90 - 18 M/C 57P reinf. TL	ME 22	Classic	F/R	2423800	7	-2.15-	1.85-2.50	103	631	316	1869	230	150	ME D18	
On Road	19	100/90 - 19 M/C 57H TL	Cruisetec	Cruising	FRONT	3576600	7	-2.50-	2.15-2.75	114	675	344	2002	230	210	ME D19; ME E19	
		100/90 - 19 M/C 57H TL	ME 888 Marathon Ultra Fr. WW	Cruising	FRONT	2407800	7	-2.50-	2.15-2.75	114	675	344	2002	230	210	ME D19; ME E19	
		100/90 - 19 M/C 57H TL	ME 888 Marathon Ultra	Cruising	FRONT	3745700	7	-2.50-	2.15-2.75	114	675	344	2002	230	210	ME D19; ME E19	
		100/90 - 19 M/C 57H TL	ME 888 Marathon Ultra OW	Cruising	FRONT	3483600	7	-2.50-	2.15-2.75	114	675	344	2002	230	210	ME D19; ME E19	
		100/90 - 19 M/C 57V TL	Lasertec	Cruising	FRONT	1530100	3/7/8	-2.50-	2.15-2.75	114	675	346	2002	230	240	ME D19; ME E19	
		100/90 - 19 M/C 57V TL	Roadtec 01	Sport Touring	FRONT	3132500	3/7/8	-2.50-	2.15-2.75	114	675	346	2002	230	240	ME D19; ME E19	
		110/80 R 19 M/C 59V TL	Roadtec 01	Sport Touring	FRONT	2670000	3/7/8	-2.50-	2.50-2.75	120	671	339	1990	243	240	ME E19	
		110/90 - 19 M/C 62H TL	Cruisetec	Cruising	FRONT	3577600	7	-2.50-	2.15-3.00	126	695	354	2057	265	210	ME E19	
		110/90 - 19 M/C 62H TL	Lasertec	Cruising	FRONT	1530800	7	-2.50-	2.15-3.00	126	695	354	2057	265	210	ME E19	
		110/90 - 19 M/C 62H TL	ME 888 Marathon Ultra	Cruising	FRONT	2661500	7	-2.50-	2.15-3.00	126	695	354	2057	265	210	ME E19	
		120/70 R 19 M/C 60V TL	Sportec M9 RR	Sport	FRONT	3617500	4/7/8	-3.50-	3.50-3.75	134	663	334	1969	250	240	-	
		120/70 ZR 19 M/C (60W) TL	Cruisetec	Cruising	FRONT	3577300	4/7/8	-3.50-	3.50-3.75	134	663	334	1969	250	280	-	
		120/70 ZR 19 M/C (60W) TL	ME 888 Marathon Ultra	Cruising	FRONT	2680700	4/7/8	-3.50-	3.50-3.75	134	663	334	1969	250	280	-	
		120/70 ZR 19 M/C 60W TL	Roadtec 01	Sport Touring	FRONT	2670100	4/7/8	-3.50-	3.50-3.75	134	663	334	1969	250	270	-	
		130/60 B 19 M/C 61H TL	Cruisetec	Cruising	FRONT	3576300	7	-3.50-	3.00-4.00	147	649	330	1930	257	210	-	
		130/60 B 19 M/C 61H TL	ME 888 Marathon Ultra	Cruising	FRONT	2634800	7	-3.50-	3.00-4.00	147	649	330	1930	257	210	-	
		130/60 B 19 M/C 66H reinf. TL	Cruisetec	Cruising	FRONT	3773300	7	-3.50-	3.00-4.00	147	649	330	1930	300	210	-	
		3.00 - 19 M/C 49S	Perfect ME 77	Classic	FRONT	0747200		-1.85-	1.60-2.15	95	665	336	1972	185	180	ME D19	
		3.00 - 19 M/C 54P reinf	Block C	Classic	F/R	0109800		-1.85-	1.60-2.15	95	665	333	1972	212	150	ME D19	
		3.25 - 19 M/C 54H TL	Lasertec	Cruising	FRONT	1531300	7	-2.15-	1.85-2.50	106	677	344	2008	212	210	ME E19	
		3.25 - 19 M/C 54H TL	Roadtec 01	Sport Touring	FRONT	3241700	7	-2.15-	1.85-2.50	106	677	344	2008	212	210	ME E19	
		3.25 - 19 M/C 54P	Block C	Classic	F/R	0109900		-2.15-	1.85-2.50	106	677	338	2006	212	150	ME E19	
		3.25 - 19 M/C 54S TL	ME 11	Classic	FRONT	0111100	7	-2.15-	1.85-2.50	106	677	341	2006	212	180	ME E19	
		3.25 - 19 M/C 54V TL	Roadtec 01	Sport Touring	FRONT	3242700	3/7/8	-2.15-	1.85-2.50	106	677	344	2008	212	240	ME E19	
		3.50 - 19 57P	Block C	Classic	F/R	0110000		-2.15-	1.85-2.50	111	689	344	2036	230	150	ME E19	
		3.50 - 19 M/C 57H TL	Lasertec	Cruising	FRONT	1531500	7	-2.15-	1.85-2.50	111	689	350	2038	230	210	ME E19	
		3.50 - 19 M/C 57S TL	Perfect ME 77	Classic	FRONT	0130900	7	-2.15-	1.85-2.50	111	689	347	2036	230	180	ME E19	
		90/90 - 19 M/C 52H TL	Roadtec 01	Sport Touring	FRONT	3627800	7	-2.15-	1.85-2.50	103	665	338	1948	200	210	ME D19	
	On Road	21	120/70 - 21 M/C 62V TL	ME 888 Marathon Ultra	Cruising	FRONT	3134100	3/7/8	-3.50-	2.75-3.75	136	713	364	2117	265	240	-
			120/70 B 21 M/C 68H reinf. TL	Cruisetec	Cruising	FRONT	3577200	7	-3.50-	2.75-3.75	136	713	362	2117	315	210	-
			120/70 B 21 M/C 68H reinf. TL	ME 888 Marathon Ultra Fr. WW	Cruising	FRONT	2718100	7	-3.50-	2.75-3.75	136	713	362	2117	315	210	-
			120/70 B 21 M/C 68H reinf. TL	ME 888 Marathon Ultra	Cruising	FRONT	2661700	7	-3.50-	2.75-3.75	136	713	362	2117	315	210	-
			130/60 - 21 M/C 63H TL	ME 888 Marathon Ultra	Cruising	FRONT	3272400	7	-3.50-	3.00-4.00	147	707	355	2081	272	210	-
			130/60 B 21 M/C 63H TL	Cruisetec	Cruising	FRONT	3797300	7	-3.50-	3.00-4.00	147	707	355	2081	272	210	-
		80/90 - 21 M/C 48H TL	ME 888 Marathon Ultra	Cruising	FRONT	2703000	7	-1.85-	1.60-2.15	91	687	348	2045	180	210	ME C21	
		90/90 - 21 M/C 54H TL	Perfect ME 77	Classic	FRONT	3139600	7	-2.15-	1.85-2.50	103	707	359	2099	212	210	ME D21	
		90/90 - 21 M/C 54H TL	Lasertec	Cruising	FRONT	1531800	7	-2.15-	1.85-2.50	103	707	359	2099	212	210	ME D21	
		90/90 - 21 M/C 54H TL	ME 888 Marathon Ultra	Cruising	FRONT	2616400	7	-2.15-	1.85-2.50	103	707	359	2099	212	210	ME D21	
		MH 90 - 21 M/C 54H TL	Cruisetec	Cruising	FRONT	3577800	7	-1.85-	1.60-2.15	92	700	354	2072	212	210	ME D21	
		MH 90 - 21 M/C 54H TL	ME 888 Marathon Ultra Fr. WW	Cruising	FRONT	2408500	7	-1.85-	1.60-2.15	92	700	354	2072	212	210	ME D21	
		MH 90 - 21 M/C 54H TL	ME 888 Marathon Ultra	Cruising	FRONT	2408600	7	-1.85-	1.60-2.15	92	700	354	2072	212	210	ME D21	
23	130/60 B 23 M/C 65H TL	ME 888 Marathon Ultra	Cruising	FRONT	2429300	7	-3.50-	3.00-4.00	147	750	382	2235	290	210			

TECHNICAL DATA TO STANDARD/69

Category	Rim	Description	Pattern Set	Application	F/R	IP Code	Footnotes	Measuring Rim width	Permitted Rim width range	Max width in service	Diameter in service	Centrifugal radius at V-Max (W=240 km/h)	Rolling Circumference +/- 2%	Load capacity (kg)	V-max	Tube
Enduro Street	17	110/70 - 17 M/C 54S M+S TL	Karoo Street	Enduro On/Off	FRONT	3778000	7	-3.00-	2.50-3.50	127	596	301	1770	212	180	ME E17
		120/70 R 17 M/C 58V TL	Karoo Street	Enduro On/Off	FRONT	3555800	4/7/8	-3.50-	3.50-3.75	133	612	308	1812	236	240	ME E17
		120/90 - 17 64S	Enduro 3 Sahara	Enduro Street	REAR	0143600		-2.75-	2.50-3.00	129	674	340	1957	280	180	ME E17
		120/90 - 17 M/C 64S	Tourance	Enduro Street	REAR	1012200		-2.75-	2.50-3.00	134	664	335	1957	280	180	ME E17
		130/80 - 17 65 T TL	Enduro 3 Sahara	Enduro Street	REAR	0142700	7	-3.00-	2.50-3.50	147	654	330	1933	290	190	ME F17 (B)
		130/80 - 17 M/C 65R M+S	Karoo 3	Enduro On/Off	REAR	2316500	5	-3.00-	2.50-3.50	147	664	339	1933	290	170	ME F17 (B)
		130/80 - 17 M/C 65S DP	Tourance	Enduro Street	REAR	3966800		-3.00-	2.50-3.50	147	654	330	1933	290	180	ME F17 (B)
		130/80 - 17 M/C 65S MST	Enduro 3 Sahara	Enduro Street	REAR	3982700		-3.00-	2.50-3.50	147	664	336	1933	290	180	ME F17 (B)
		130/80 R 17 M/C 65S TL	Tourance	Enduro Street	REAR	1086800	7	-3.00-	3.00-3.50	143	654	330	1933	290	180	ME F17 (B)
		130/80 R 17 M/C 65V M+S TL	Karoo Street	Enduro On/Off	REAR	3556000	3/7/8	-3.00-	3.00-3.50	143	654	330	1933	290	240	ME F17 (B)
		140/70 - 17 M/C 66S M+S TL	Karoo Street	Enduro On/Off	REAR	3778100	7	-3.75-	3.50-4.50	162	642	324	1897	300	180	ME K17
		140/80 - 17 M/C 69H MST	Enduro 3 Sahara	Enduro Street	REAR	3982900		-3.50-	2.75-3.75	158	682	348	1981	325	210	ME K17
		140/80 - 17 M/C 69R M+S	Karoo 3	Enduro On/Off	REAR	2316600	5	-3.50-	2.75-3.75	158	682	348	1981	325	170	ME K17
		140/80 R 17 M/C 69H TL	Tourance	Enduro Street	REAR	1012100	7	-3.50-	3.50-3.75	154	672	339	1981	325	210	ME K17
		140/80 R 17 M/C 69V M+S TL	Karoo Street	Enduro On/Off	REAR	3556100	3/7/8	-3.50-	3.50-3.75	154	672	339	1981	325	240	ME K17
		150/70 - 17 M/C 69R M+S TL	Karoo 3	Enduro On/Off	REAR	2316300	5 / 7	-4.25-	3.50-4.50	169	668	340	1939	325	170	ME K17
		150/70 R 17 M/C 69H TL	Tourance	Enduro Street	REAR	3079900	7	-4.25-	4.00-4.50	165	668	332	1939	325	210	ME K17
		150/70 R 17 M/C 69V M+S TL	Karoo Street	Enduro On/Off	REAR	3142800	3/7/8	-4.25-	4.00-4.50	165	668	332	1939	325	240	ME K17
		150/70 R 17 M/C 69V TL	Tourance Next 2	Enduro Street	REAR	3961500	3/7/8	-4.25-	4.00-4.50	165	668	332	1939	325	240	ME K17
		150/70 R 17 M/C 69V TL	Tourance	Enduro Street	REAR	1127900	3/7/8	-4.25-	4.00-4.50	165	668	332	1939	325	240	ME K17
		170/60 R 17 M/C 72T M+S TL	Karoo 3	Enduro On/Off	REAR	2316400	5 / 7	-4.50-	4.50-5.50	190	650	328	1921	355	190	ME G17
		170/60 R 17 M/C 72V M+S TL	Karoo Street	Enduro On/Off	REAR	3142900	3/7/8	-4.50-	4.50-5.50	190	650	328	1921	355	240	ME G17
		170/60 R 17 M/C 72V TL	Tourance	Enduro Street	REAR	2763500	3/7/8	-4.50-	4.50-5.50	190	650	328	1921	355	240	ME G17
		170/60 R 17 M/C 72V TL	Tourance Next 2	Enduro Street	REAR	3960500	3/7/8	-4.50-	4.50-5.50	190	650	328	1921	355	240	ME G17
		170/60 ZR 17 M/C 72W TL	Tourance Next 2	Enduro Street	REAR	3960800	4/7/8	-4.50-	4.50-5.50	190	650	328	1921	355	270	ME G17
		180/55 R 17 M/C 73V M+S TL	Karoo Street	Enduro On/Off	REAR	3555900	4/7/8	-5.50-	5.50-6.00	196	644	325	1903	365	240	ME G17
		18	110/80 - 18 M/C 58S	Enduro 3 Sahara	Enduro Street	REAR	1846800	5	-2.50-	2.15-3.00	125	655	330	1912	236	170
		120/80 - 18 M/C 62S DP	Tourance	Enduro Street	REAR	3966600		-2.75-	2.50-3.00	134	673	339	1960	265	180	ME F18
		120/80 - 18 M/C 62S MST	Enduro 3 Sahara	Enduro Street	REAR	3966700		-2.75-	2.50-3.00	134	673	339	1960	265	180	ME F18
		140/80 - 18 M/C 70R M+S	Karoo 3	Enduro On/Off	REAR	2316700	5	-3.50-	2.75-3.75	158	697	352	2057	335	170	ME F18
		140/80 - 18 M/C 70R MST	Karoo Extreme	Enduro On/Off	REAR	2470500	5	-3.50-	2.75-3.75	180	707	358	2057	335	170	ME F18
		140/80 - 18 M/C 70S MST	Enduro 3 Sahara	Enduro Street	REAR	3983000		-3.50-	2.75-3.75	158	697	352	2057	335	180	ME F18
		150/70 - 18 M/C 70R M+S	Karoo 3	Enduro On/Off	REAR	2316800	5	-4.25-	3.50-4.50	169	693	353	2014	335	170	ME F18
		150/70 R 18 M/C 70H TL	Karoo Street	Enduro On/Off	REAR	3735400	3/7/8	-4.25-	4.00-4.50	165	681	345	2014	335	210	ME F18
		150/70 R 18 M/C 70H TT	Karoo Street	Enduro On/Off	REAR	3735200		-4.25-	4.00-4.50	165	681	345	2014	335	210	ME F18
		150/70 R 18 M/C 70S MST TL	Karoo Extreme	Enduro On/Off	REAR	3560500	3/7/8	-4.25-	4.00-4.50	165	681	345	2014	335	180	ME F18
		150/70 R 18 M/C 70V M+S TL	Karoo Street	Enduro On/Off	REAR	3143000	3/7/8	-4.25-	4.00-4.50	165	681	345	2014	335	240	ME F18
		150/70 R 18 M/C 70V TL	Tourance Next 2	Enduro Street	REAR	3961400	3/7/8	-4.25-	4.00-4.50	165	681	345	2014	335	240	ME F18
		2.75 - 18 M/C 42P TT	Enduro 3 Sahara	Enduro Street	FRONT	2484600		-1.85-	1.50-1.85	86	625	313	1851	180	150	ME C18
		4.00 - 18 64R	Enduro 2	Enduro Street	REAR	0139200		-2.50-	1.85-3.00	130	697	352	2026	280	170	ME F18
		4.00 - 18 64S	Enduro 3 Sahara	Enduro Street	REAR	0143000		-2.50-	1.85-3.00	130	697	352	2026	280	180	ME F18
		90/90 - 18 M/C 45P	Enduro 3 Sahara	Enduro Street	REAR	2324000	7	-2.15-	1.85-2.50	103	631	321	1869	195	210	ME D18
	19	100/90 - 19 M/C 57H TL	Tourance	Enduro Street	FRONT	3773000	7	-2.50-	2.15-2.75	114	675	344	2002	230	210	ME D19; ME E19
		100/90 - 19 M/C 57H TL	Tourance K	Enduro Street	FRONT	3907100	7	-2.50-	2.15-2.75	114	675	344	2002	230	210	ME D19; ME E19
		100/90 - 19 M/C 57S TT	Tourance	Enduro Street	FRONT	3908100		-2.50-	2.15-2.75	130	685	-	2002	230	130	ME E19
		100/90 - 19 M/C 57V M+S TL	Karoo Street	Enduro On/Off	FRONT	3555700	3/7/8	-2.50-	2.15-2.75	114	675	346	2002	230	240	ME D19; ME E19
		110/80 - 19 M/C 59H DP TL	Tourance	Enduro Street	FRONT	3967200	7	-2.50-	2.15-2.75	114	675	344	2002	230	210	ME D19; ME E19
		110/80 - 19 M/C 59H TL	Tourance	Enduro Street	FRONT	3079800	7	-2.50-	2.15-2.75	114	675	344	2002	230	210	ME D19; ME E19
		110/80 R 19 M/C 59R M+S TL	Karoo 3	Enduro On/Off	FRONT	2316000	5 / 7	-2.50-	2.15-3.00	125	681	339	1990	243	170	ME E19
		110/80 R 19 M/C 59V M+S TL	Karoo Street	Enduro On/Off	FRONT	3142500	3/7/8	-2.50-	2.15-3.00	122	671	339	1990	243	240	ME E19
		110/80 R 19 M/C 59V TL	Tourance	Enduro Street	FRONT	2315900	3/7/8	-2.50-	2.50-3.00	122	671	339	1990	243	240	ME E19
		110/80 R 19 M/C 59V TL	Tourance Next 2	Enduro Street	FRONT	3960600	3/7/8	-2.50-	2.50-3.00	122	671	339	1990	243	240	ME E19
		120/70 R 19 M/C 60T M+S TL	Karoo 3	Enduro On/Off	FRONT	2316100	5 / 7	-3.50-	3.00-3.75	133	663	334	1966	250	190	-
		120/70 R 19 M/C 60V M+S TL	Karoo Street	Enduro On/Off	FRONT	3142600	4/7/8	-3.50-	3.50-3.75	134	663	334	1969	250	240	-
		120/70 R 19 M/C 60V TL	Tourance Next 2	Enduro Street	FRONT	3960400	3/7/8	-3.50-	3.00-3.75	133	663	334	1966	250	240	-
		120/70 ZR 19 M/C 60W TL	Tourance Next 2	Enduro Street	FRONT	3960700	4/7/8	-3.50-	3.00-3.75	133	663	334	1966	250	270	-
		90/90 - 19 M/C 52P	Enduro 3 Sahara	Enduro Street	FRONT	1846600	7	-2.15-	1.85-2.50	103	665	338	1948	200	210	ME D19

70/ TECHNICAL DATA TO STANDARD

Category	Rim	Description	Pattern Set	Application	F/R	IP Code	Footnote	Measuring Rim width	Permitted Rim width range	Max width in service	Diameter in service	Centrifugal radius at V-Max (W=240 km/h)	Rolling Circumference +/- 2%	Load capacity (kg)	V-max	Tube	
Enduro Street	21	3.00 - 21 51R TT	Enduro 1	Enduro Street	FRONT	0139400		-1.85-	1.60-2.15	95	723	365	2123	195	170	ME D21	
		80/90 - 21 M/C 48S	Enduro 3 Sahara	Enduro Street	FRONT	0143500		-1.85-	1.60-2.15	91	687	348	2045	180	210	ME C21	
		80/90 - 21 M/C 48S	Tourance	Enduro Street	FRONT	2059200		-1.85-	1.60-2.15	91	687	348	2045	180	210	ME C21	
		90/90 - 21 M/C 54H MST TL	Enduro 3 Sahara	Enduro Street	FRONT	3971400	7	-2.15-	1.85-2.50	103	707	359	2099	212	210	ME D21	
		90/90 - 21 M/C 54H TL	Tourance	Enduro Street	FRONT	3078600	7	-2.15-	1.85-2.50	103	707	359	2099	212	210	ME D21	
		90/90 - 21 M/C 54H TL	Karoo Street	Enduro On/Off	FRONT	3735300	3/7/8	-2.15-	1.85-2.50	103	707	359	2099	212	210	ME D21	
		90/90 - 21 M/C 54H TT	Karoo Street	Enduro On/Off	FRONT	3735100		-2.15-	1.85-2.50	103	707	359	2099	212	210	ME D21	
		90/90 - 21 M/C 54R M+S TL	Karoo 3	Enduro On/Off	FRONT	2316200	5 / 7	-2.15-	1.85-2.50	103	707	356	2099	212	170	ME D21	
		90/90 - 21 M/C 54R MST TT Desert	Karoo Extreme	Enduro On/Off	FRONT	3908300		-2.15-	1.85-2.50	103	707	356	2099	212	170	ME D21	
		90/90 - 21 M/C 54S	Tourance	Enduro Street	FRONT	3555600		-2.15-	1.85-2.50	103	707	356	2099	212	180	ME D21	
		90/90 - 21 M/C 54S M+S TL	Karoo 3	Enduro On/Off	FRONT	3560300		-2.15-	1.85-2.50	103	707	356	2099	212	180	ME D21	
		90/90 - 21 M/C 54S MST	Enduro 3 Sahara	Enduro Street	FRONT	3966200		-2.15-	1.85-2.50	103	707	356	2099	212	180	ME D21	
		90/90 - 21 M/C 54S MST TT	Karoo Extreme	Enduro On/Off	FRONT	3908200		-2.15-	1.85-2.50	103	707	356	2099	212	180	ME D21	
	90/90 - 21 M/C 54V M+S TL	Karoo Street	Enduro On/Off	FRONT	3142700	3/7/8	-2.15-	1.85-2.50	103	707	361	2099	212	240	ME D21		
	90/90 - 21 M/C 54V TL	Tourance Next 2	Enduro Street	FRONT	3961200	3/7/8	-2.15-	1.85-2.50	103	707	361	2099	212	240	ME D21		
Off Road	18	100/100 - 18 M/C 59M MST	MC 360 Mid Hard	Off-Road	REAR	2763100	5	-2.50-	2.15-2.75	130	681	344	1984	243	130	MECR 18F NHS	
		100/100 - 18 M/C 59M MST	MC 360 Mid Soft	Off-Road	REAR	2763000	5	-2.50-	2.15-2.75	130	681	344	1984	243	130	MECR 18F NHS	
		110/100 - 18 M/C 64M MST	MC 360 Mid Hard	Off-Road	REAR	2762500	5	-2.50-	2.15-3.00	143	703	-	2045	280	130	MECR 18F NHS	
		110/100 - 18 M/C 64M MST	MC 360 Mid Soft	Off-Road	REAR	2762400	5	-2.50-	2.15-3.00	143	703	-	2045	280	130	MECR 18F NHS	
		110/80 - 18 M/C 58R M+S	MCE 6 Days Extreme	Off-Road	REAR	3841700	5	-2.50-	2.15-3.00	125	655	330	1912	236	170	ME E19	
		120/100 - 18 M/C 68M MST	MC 360 Mid Hard	Off-Road	REAR	2762700	5	-2.75-	2.50-3.00	153	725	-	2105	315	130	ME CR 18F NHS	
		120/100 - 18 M/C 68M MST	MC 360 Mid Soft	Off-Road	REAR	2762600	5	-2.75-	2.50-3.00	153	725	-	2105	315	130	ME CR 18F NHS	
		120/80 - 18 M/C 62R	MC 360 Mid Soft	Off-Road	REAR	3822900	5	-2.75-	2.50-3.00	134	673	339	1960	265	170	ME F18Y	
		120/90 - 18 M/C 65M M+S	MCE 6 Days Extreme	Off-Road	REAR	1623800	5	-2.75-	2.50-3.00	134	699	353	2032	290	130	ME F18Y	
		120/90 - 18 M/C 65R M+S	MCE 6 Days Extreme	Off-Road	REAR	3286600	5	-2.75-	2.50-3.00	134	699	353	2032	290	170	ME F18Y	
		130/90 - 18 M/C 69M M+S	MCE 6 Days Extreme	Off-Road	REAR	1907200	5	-3.00-	2.50-3.50	147	719	364	2087	325	130	ME F18Y	
		140/80 - 18 M/C 70M M+S	MCE 6 Days Extreme	Off-Road	REAR	2477700	5	-3.50-	2.50 2)-3.75	158	707	358	2057	335	130	ME F18Y	
		140/80 - 18 M/C 70M M+S	MCE 6 Days Extreme Super Soft	Off-Road	REAR	3864900	5	-3.50-	2.50 2)-3.75	158	707	358	2057	335	130	ME F18Y	
		140/80 - 18 M/C 70M M+S	MCE 6 Days Extreme Medium	Off-Road	REAR	4067900	5	-3.50-	2.50 2)-3.75	158	707	358	2057	335	130	ME F18Y	
		140/80 - 18 M/C 70M M+S	MCE 6 Days Extreme Soft	Off-Road	REAR	2529900	5	-3.50-	2.50 2)-3.75	158	707	358	2057	335	130	ME F18Y	
		140/80 - 18 M/C 70M MST	MC 360 Mid Hard	Off-Road	REAR	2900900	5	-3.50-	2.75-3.75	180	707	358	2057	335	130	ME F18Y	
		140/80 - 18 M/C 70M MST	MC 360 Mid Soft	Off-Road	REAR	2900700	5	-3.50-	2.75-3.75	180	707	358	2057	335	130	ME F18Y	
	Off Road	19	100/90 - 19 57M NHS	MC 360 Mid Soft R	Off-Road	REAR	4023300	6	-2.50-	2.15-2.75	130	685	-	2002			ME E19
			100/90 - 19 M/C 57M MST	MC 360 Mid Hard	Off-Road	REAR	2762900	5	-2.50-	2.15-2.75	130	685	-	2002	230	130	ME E19
		100/90 - 19 M/C 57M MST	MC 360 Mid Soft	Off-Road	REAR	2762800	5	-2.50-	2.15-2.75	130	685	-	2002	230	130	ME E19	
		110/90 - 19 62M NHS	MC 360 Mid Soft R	Off-Road	REAR	4023400	6	-2.50-	2.15-3.00	143	705	-	2057			ME E19	
		110/90 - 19 M/C 62M MST	MC 360 Mid Hard	Off-Road	REAR	2762300	5	-2.50-	2.15-3.00	143	705	-	2057	265	130	ME E19	
		110/90 - 19 M/C 62M MST	MC 360 Mid Soft	Off-Road	REAR	2762200	5	-2.50-	2.15-3.00	143	705	-	2057	265	130	ME E19	
		120/80 - 19 63M NHS	MC 360 Mid Soft R	Off-Road	REAR	4023500	6	-2.75-	2.50-3.00	153	699	352	2039			ME E19	
		120/80 - 19 M/C 63M MST	MC 360 Mid Hard	Off-Road	REAR	2763300	5	-2.75-	2.50-3.00	153	699	352	2039	272	130	ME E19	
		120/80 - 19 M/C 63M MST	MC 360 Mid Soft	Off-Road	REAR	2763200	5	-2.75-	2.50-3.00	153	699	352	2039	272	130	ME E19	
Off Road	21	80/100 - 21 M/C 51M MST	MC 360 Mid Hard	Off-Road	FRONT	2762100	5	-1.85-	1.60- 2.15	104	713	-	2093	195	130	ME C21	
		80/100 - 21 M/C 51M MST	MC 360 Mid Soft	Off-Road	FRONT	2762000	5	-1.85-	1.60- 2.15	104	713	-	2093	195	130	ME C21	
		80/100 - 21 M/C 51M MST	MC 360 Mid Soft R	Off-Road	FRONT	4023200	5	-1.85-	1.60- 2.15	104	713	-	2093	195	130	ME C21	
		90/100 - 21 M/C 57M MST	MCE 6 Days Extreme Super Soft	Off-Road	FRONT	4074600		-2.15-	1.85-2.50	103	735	371	2153	230	130	ME D21	
		90/100 - 21 M/C 57R M+S	MCE 6 Days Extreme	Off-Road	FRONT	3286500	5	-2.15-	1.85-2.50	103	735	371	2153	230	170	ME D21	
		90/90 - 21 M/C 54M M+S	MCE 6 Days Extreme	Off-Road	FRONT	4073200	5	-2.15-	1.60 2)-2.50	103	715	360	2099	212	130	ME D21	
		90/90 - 21 M/C 54M M+S	MCE 6 Days Extreme	Off-Road	FRONT	2477600	5	-2.15-	1.60 2)-2.50	103	715	360	2099	212	130	ME D21	
		90/90 - 21 M/C 54M MST	MC 360 Mid Hard	Off-Road	FRONT	2900800	5	-2.15-	1.85-2.50	118	715	360	2099	212	130	ME D21	
		90/90 - 21 M/C 54M MST	MC 360 Mid Soft	Off-Road	FRONT	2900600	5	-2.15-	1.85-2.50	118	715	360	2099	212	130	ME D21	
Scooter	10	100/80 - 10 53L TL	Roadtec Scooter	Scooter	F/R	3844500	7	-2.50-	2.15-2.75	112	426		1238	206	120	ME D 10	
		100/90 - 10 61J reinf TL	Roadtec Scooter	Scooter	F/R	3844600	7	-2.50-	2.15-2.75	112	446		1298	257	100	ME F 10 33G/90°-SV	
		120/90 - 10 66L TL	Roadtec Scooter	Scooter	F/R	3844800	7	-2.75-	2.50-3.00	132	486		1405	300	120	-	
		130/70 - 10 59L reinf. TL	Roadtec Scooter	Scooter	F/R	3844900	7	-3.50-	3.00-4.00	144	448		1304	243	120	-	
		130/90 - 10 61L TL	Roadtec Scooter	Scooter	F/R	3845000	7	-3.00-	2.50-3.50	145	504		1459	257	120	-	
		3.00 - 10 50J reinf. TL	Roadtec Scooter	Scooter	F/R	3844300	7	-2.15-	1.85-2.50	90	422		1235	190	100	ME D 10	
		90/90 - 10 50J TL	Roadtec Scooter	Scooter	F/R	3844400	7	-2.15-	1.85-2.50	102	428		1264	190	100	ME D 10	

TECHNICAL DATA TO STANDARD/71

Category	Rim	Description	Pattern Set	Application	F/R	IP Code	Futnote	Measuring Rim width	Permitted Rim width range	Max width in service	Diameter in service	Centrifugal radius at V-Max (V=240 km/h)	Rolling Circumference +/- 2%	Load capacity (kg)	V-max	Tube
Scooter	11	130/70 - 11 60L TL reinf	Roadtec Scooter	Scooter	F/R	3845100	7	-3.50-	3.00-4.00	144	473		1378	250	120	-
	12	110/70 - 12 47P TL	Roadtec Scooter	Scooter	F/R	3995300	7	-3.00-	2.50-3.50	124	469		1372	175	150	-
		110/90 - 12 64P TL	Feelfree	Scooter	FRONT	1660000	7	-2.50-	2.15-3.00	123	517		1504	280	150	-
		110/90 - 12 64P TL	Roadtec Scooter	Scooter	FRONT	3845300	7	-2.50-	2.15-3.00	123	517		1504	280	150	-
		120/70 - 12 51P TL	Roadtec Scooter	Scooter	F/R	3845400	7	-3.50-	2.75-3.75	135	485		1414	195	150	-
		130/70 - 12 62L reinf. TL	Roadtec Scooter	Scooter	F/R	3845500	7	-3.50-	3.00-4.00	144	499		1456	265	120	-
		130/70 - 12 62P reinf TL	Roadtec Scooter	Scooter	REAR	3845600	7	-3.50-	3.00-4.00	145	499		1456	265	150	-
		140/70 - 12 60L TL	Roadtec Scooter	Scooter	F/R	3845700	7	-3.75-	3.50-4.50	157	515		1498	250	120	-
		140/70 - 12 65P reinf. TL	Roadtec Scooter	Scooter	REAR	3846500	7	-3.75-	3.50-4.50	157	515		1498	290	150	-
	13	110/70 - 13 M/C 48P TL	Roadtec Scooter	Scooter	FRONT	3776700	7	-3.00-	2.50-3.50	127	494	250	1462	180	150	-
		110/90 - 13 M/C 56P TL	Roadtec Scooter	Scooter	FRONT	3845800	7	-2.50-	2.15-3.00	125	542	271	1595	224	150	-
		120/70 - 13 M/C 53L TL	Roadtec Scooter	Scooter	F/R	3845900	7	-3.50-	3.00-3.75	137	510		1504	206	120	-
		130/60 - 13 M/C 53P TL	Roadtec Scooter	Scooter	FRONT	3846000	7	-3.50-	3.00-4.00	147	496		1468	206	150	-
		130/60 - 13 M/C 60P reinf. TL	Roadtec Scooter	Scooter	REAR	4017300	7	-3.50-	3.00-4.00	147	496		1468	250	150	-
		130/70 - 13 M/C 57P DP TL	Tourance	Enduro Street	REAR	3849200	7	-3.50-	3.00-4.00	147	524	265	1546	230	150	-
		130/70 - 13 M/C 63P reinf. TL	Roadtec Scooter	Scooter	REAR	3846600	7	-3.50-	3.00-4.00	147	524	265	1546	272	150	-
		140/60 - 13 M/C 57L TL	Roadtec Scooter	Scooter	F/R	3846100	7	-4.00-	3.50-4.50	160	510		1504	230	120	-
		150/70 - 13 M/C 64S TL	Roadtec Scooter	Scooter	REAR	3556900	7	-4.25-	3.50-4.50	169	554	281	1631	280	180	-
	14	100/80 - 14 M/C 54S reinf. TL	Roadtec Scooter	Scooter	F/R	3987100	7	-2.50-	2.15-2.75	114	528	266	1558	212	180	-
		100/90 - 14 M/C 57P reinf. TL	Roadtec Scooter	Scooter	REAR	3846700	7	-2.50-	2.15-2.75	114	548	277	1619	230	150	-
		100/90 - 14 M/C 57P reinf. TL	Sportec Street	Scooter	REAR	2919400	7	-2.50-	2.15-2.75	114	548	277	1619	230	150	-
		110/80 - 14 M/C 53P DP TL	Tourance	Enduro Street	FRONT	3849100	7	-2.50-	2.15-3.00	125	544	275	1607	206	150	-
		110/80 - 14 M/C 59S reinf. TL	Roadtec Scooter	Scooter	FRONT	3995200	7	-2.50-	2.15-3.00	125	544	275	1607	243	180	-
		110/80 - 14 M/C 59S reinf. TL	Sportec Street	Scooter	REAR	2716500	7	-2.50-	2.15-3.00	125	544	275	1607	243	180	-
		120/70 - 14 M/C 55S TL	Roadtec Scooter	Scooter	F/R	3846300	7	-3.50-	3.00-3.75	137	536	270	1582	218	180	-
		120/70 R 14 M/C 55H TL	Feelfree	Scooter	FRONT	1816600	7	-3.50-	3.50-3.75	134	536	270	1582	218	210	-
		120/80 - 14 M/C 58S TL	Roadtec Scooter	Scooter	F/R	3556800	7	-2.75-	2.50-3.00	134	562	284	1655	236	180	-
	140/60 - 14 M/C 64P reinf. TL	Roadtec Scooter	Scooter	REAR	3846800	7	-3.75-	3.50-4.50	162	536	270	1582	280	150	-	
	140/70 - 14 M/C 68P reinf. TL	Roadtec Scooter	Scooter	REAR	3846900	7	-3.75-	3.50-4.50	160	566	286	1667	315	150	-	
	150/70 - 14 M/C 66S TL	Roadtec Scooter	Scooter	REAR	3518000	7	-4.25-	3.50-4.50	169	580	294	1709	300	180	-	
	160/60 R 14 M/C 65H TL	Feelfree	Scooter	REAR	1816900	7	-4.50-	4.25-5.00	177	562	284	1655	290	210	-	
	70/90 - 14 M/C 34S TL	Sportec Street	Scooter	FRONT	2716100	7	-1.60-	1.40-1.85	79	490	247	1456	118	180	-	
	80/80 - 14 M/C 43P TL Reinf	Feelfree	Scooter	FRONT	2626800	7	-1.85-	1.60-2.15	91	492	248	1462	155	180	-	
	80/80 - 14 M/C 43S reinf. TL	Sportec Street	Scooter	F/R	2761700	7	-1.85-	1.60-2.15	91	492	248	1462	155	180	-	
	80/90 - 14 M/C 40S TL	Sportec Street	Scooter	REAR	2715900	7	-1.85-	1.60-2.15	91	510	257	1510	140	180	-	
	80/90 - 14 M/C 40S TL	Sportec Street	Scooter	FRONT	2716000	7	-1.85-	1.60-2.15	91	510	257	1510	140	180	-	
	90/80 - 14 M/C 49S reinf. TL	Roadtec Scooter	Scooter	FRONT	3987000	7	-2.15-	1.85-2.50	103	510	257	1510	185	180	-	
	90/80 - 14 M/C 49S reinf. TL	Sportec Street	Scooter	REAR	2761800	7	-2.15-	1.85-2.50	103	510	257	1510	185	180	-	
	90/80 - 14 M/C 49S reinf. TL	Sportec Street	Scooter	FRONT	2761900	7	-2.15-	1.85-2.50	103	510	257	1510	185	180	-	
	90/90 - 14 M/C 46P TL	Roadtec Scooter	Scooter	FRONT	3846200	7	-2.15-	1.85-2.50	103	530	267	1564	170	150	-	
	90/90 - 14 M/C 46S TL	Sportec Street	Scooter	REAR	2716300	7	-2.15-	1.85-2.50	103	530	267	1564	170	180	-	
	90/90 - 14 M/C 46S TL	Sportec Street	Scooter	FRONT	2716200	7	-2.15-	1.85-2.50	103	530	267	1564	170	180	-	
15	120/70 - 15 M/C 56S TL	Roadtec Scooter	Scooter	FRONT	3517900	7	-3.50-	2.75-3.75	136	561	283	1658	224	180	-	
	120/70 R 15 M/C 56H TL	Feelfree	Scooter	FRONT	1816700	7	-3.50-	3.50-3.75	134	561	283	1658	224	210	-	
	160/60 R 15 M/C 67H TL	Feelfree	Scooter	REAR	1816800	7	-4.50-	4.25-5.00	177	587	296	1730	307	210	-	
16	100/80 - 16 M/C 50P TL	Roadtec Scooter	Scooter	FRONT	3000000	7	-2.50-	2.15-2.75	114	578	291	1709	190	150	-	
	110/70 - 16 M/C 52P TL	Roadtec Scooter	Scooter	FRONT	3846400	7	-3.00-	2.50-3.50	126	570	288	1691	200	150	-	
	110/70 - 16 M/C 52S TL	Feelfree	Scooter	FRONT	1677800	7	-3.00-	2.50-3.50	126	570	288	1691	200	180	-	
	110/70 - 16 M/C 52S TL	Roadtec Scooter	Scooter	FRONT	3120200	7	-3.00-	2.50-3.50	126	570	288	1691	200	180	-	
	120/80 - 16 M/C 60P TL	Roadtec Scooter	Scooter	REAR	3000100	7	-2.75-	2.50-3.00	134	612	309	1806	250	150	ME-C/D16	
	130/70 - 16 M/C 61 S TL	Roadtec Scooter	Scooter	REAR	3847000	7	-3.50-	3.00-4.00	147	600	303	1776	257	180	-	
	130/70 R 16 M/C 61S TL	Feelfree	Scooter	REAR	1922100	7	-3.50-	3.50-4.00	143	600	303	1776	257	180	-	
	130/70 R 16 M/C 61S TL	Roadtec Scooter	Scooter	REAR	3974400	7	-3.50-	3.50-4.00	143	600	303	1776	257	180	-	
	130/80 - 16 M/C 64P TL	Feelfree	Scooter	REAR	1659900	7	-3.00-	2.50-3.50	147	628	317	1854	280	150	-	
	130/80 - 16 M/C 64P TL	Roadtec Scooter	Scooter	REAR	3847100	7	-3.00-	2.50-3.50	147	628	317	1854	280	150	-	
	140/70 - 16 M/C 65P TL	Roadtec Scooter	Scooter	REAR	3847200	7	-3.75-	3.50-4.50	161	616	311	1818	290	150	-	
17	70/90 - 17 M/C 38S TL	Sportec Street	Scooter	F/R	2903700	7	-1.60-	1.40-1.85	79	566	285	1685	132	180	-	
	80/90 - 17 M/C 44S TL	Sportec Street	Scooter	F/R	2903800	7	-1.85-	1.60-2.15	91	586	295	1740	160	180	-	
	90/80 - 17 M/C 46S TL	Sportec Street	Scooter	F/R	2903900	7	-2.15-	1.85-2.50	103	586	295	1740	170	180	-	

72/ COMPARATIVE CHART FOR METRIC-DECIMAL SIZE DESCRIPTION

Tyre Size	Load index		Permitted rim width	Tyre size			
	standard	reinforced		alphanumeric	Metric		
					100	90	80
2.75 - 16	40	46	1.50 - 1.85	MH 90 - 16	80 / 100 - 16	80 / 90 - 16	90 / 80 - 16
3.00 - 16	40	48	1.60 - 2.15	MH 90 - 16	90 / 100 - 16	90 / 90 - 16	100 / 80 - 16
3.25 - 16	48	55	1.85 - 2.50	MJ 90 - 16	100 / 100 - 16	100 / 90 - 16	110 / 80 - 16
3.50 - 16	52	58	1.85 - 2.50	ML 90 - 16	100 / 100 - 16	100 / 90 - 16	110 / 80 - 16
4.60 - 16	59	58	1.85 - 3.00	MM 90 - 16	100 / 100 - 16	110 / 90 - 16	120 / 80 - 16
5.00 - 16	72	74	2.50 - 3.50	MT 90 - 16	120 / 100 - 16	130 / 90 - 16	140 / 80 - 16
5.50 - 16	75	77	2.50 - 3.50	MU 85 - 16	130 / 100 - 16	140 / 90 - 16	150 / 80 - 16
2.75 - 17	41	47	1.50 - 1.85	MH 90 - 17	80 / 100 - 17	80 / 90 - 17	90 / 80 - 17
3.00 - 17	41	50	1.60 - 2.15	MH 90 - 17	90 / 100 - 17	90 / 90 - 17	100 / 80 - 17
4.50 - 17	67	50	2.15 - 3.00	MR 90 - 17	110 / 100 - 17	130 / 90 - 17	140 / 80 - 17
4.60 - 17	62	50	1.85 - 3.00	MS 90 - 17	100 / 100 - 17	110 / 90 - 17	120 / 80 - 17
5.10 - 17	67	50	2.50 - 3.50	MT 90 - 17	110 / 100 - 17	130 / 90 - 17	140 / 80 - 17
2.75 - 18	42	48	1.50 - 1.85	MH 90 - 18	80 / 100 - 18	80 / 90 - 18	90 / 80 - 18
3.00 - 18	47	52	1.60 - 2.15	MH 90 - 18	90 / 100 - 18	90 / 90 - 18	100 / 80 - 18
3.25 - 18	52	59	1.85 - 2.50	MJ 90 - 18	100 / 100 - 18	100 / 90 - 18	110 / 80 - 18
3.50 - 18	56	62	1.85 - 2.50	ML 90 - 18	100 / 100 - 18	100 / 90 - 18	110 / 80 - 18
3.60 - 18	51	62	1.85 - 2.50	MH 90 - 18	100 / 100 - 18	90 / 90 - 18	100 / 80 - 18
4.00 - 18	64	69	2.15 - 3.00	MN 90 - 18	110 / 100 - 18	120 / 90 - 18	130 / 80 - 18
4.10 - 18	60	69	1.85 - 3.00	ML 90 - 18	100 / 100 - 18	100 / 90 - 18	110 / 80 - 18
4.25/85 - 18	64	69	1.85 - 3.00	MM 90 - 18	110 / 100 - 18	110 / 90 - 18	120 / 80 - 18
4.25 - 18	66	69	2.15 - 3.00	ML 90 - 18	110 / 100 - 18	120 / 90 - 18	130 / 80 - 18
4.60 - 18	63	69	1.85 - 3.00	MR 90 - 18	110 / 100 - 18	120 / 90 - 18	130 / 80 - 18
3.00 - 19	49	54	1.60 - 2.15	MH 90 - 19	90 / 100 - 19	90 / 90 - 19	100 / 80 - 19
3.25 - 19	54	54	1.85 - 2.50	MJ 90 - 19	100 / 100 - 19	100 / 90 - 19	110 / 80 - 19
3.50 - 19	57	54	1.85 - 2.50	ML 90 - 19	100 / 100 - 19	100 / 90 - 19	110 / 80 - 19
3.60 - 19	52	54	1.85 - 2.50	MH 90 - 19	100 / 100 - 19	90 / 90 - 19	100 / 80 - 19
2.75 - 21	45	54	1.50 - 1.85	MH 90 - 21	80 / 100 - 21	80 / 90 - 21	90 / 80 - 21
3.00 - 21	51	57	1.60 - 2.15	MH 90 - 21	90 / 100 - 21	90 / 90 - 21	100 / 80 - 21

Load index and speed index

LOAD INDEX

The rating indicates the maximum speed the tyre is homologated for. The indications regarding speed rating and load capacity in the operating manual of the motorcycle must be followed, Tyres fitted must be marked with the same or higher index. The load and speed indices (SI and LI) are indicated in the technical data for each METZELER tyre.

EXAMPLE

METZELER ROADTEC Z8 INTERACT 120/70 ZR 17 M/C (58W) The tyre has a load capacity (58) of max. 236 kg/520 lbs at its permitted max. speed (W).

LOAD CARRYING CAPACITIES - LOAD INDEX

LI	Kg.	lbs	LI	Kg.	lbs	LI	Kg.	lbs	LI	Kg.	lbs	LI	Kg.	lbs
20	80	176	34	118	260	48	180	397	62	265	584	76	400	882
21	82,5	182	35	121	267	49	185	408	63	272	600	77	412	908
22	85	187	36	125	276	50	190	414	64	280	617	78	425	937
23	87,5	193	37	128	282	51	195	430	65	290	639	79	437	963
24	90	198	38	132	291	52	200	441	66	300	661	80	450	992
25	92,5	207	39	136	300	53	206	454	67	307	677	81	462	1019
26	95	209	40	140	309	54	212	467	68	315	694	82	475	1047
27	97	214	41	145	320	55	218	481	69	325	716	83	487	1074
28	100	220	42	150	331	56	224	494	70	335	739	84	500	1102
29	103	227	43	155	342	57	230	507	71	345	761	85	515	1135
30	106	234	44	160	353	58	236	520	72	355	783	86	530	1168
31	109	240	45	165	364	59	243	536	73	365	805	87	545	1202
32	112	247	46	170	375	60	250	551	74	375	827			
33	115	254	47	175	386	61	257	567	75	387	853			

* = at normal pressure

SPEED CATEGORIES - SPEED SYMBOL

Code letters	km/h	mph	Code letters	km/h	mph	Code letters	km/h	mph	Code letters	km/h	mph
B	50	31	J	100	62	Q	160	100	V/VB	up to 240	up to 149
C	60	37	K	110	68	R	170	106	(V)/(VB)	over 240	over 149
D	65	40	L	120	74	S	180	112	W	up to 270	up to 168
E	70	44	M	130	81	T	190	118	(W)	over 270	over 168
F	80	50	N	140	87	U	200	124			
G	90	56	P	150	93	H	210	130			

Footnotes for Technical data to Standard

- 3) Indicated load capacity are valid up to 210km/h.
- 4) Indicated load capacity are valid up to 240km/h.
- 5) If homologated Off-road tyres are used on normal roads, we suggest to ride the bike at maximum speed only for short periods. Otherwise irregular wear of the knobs may occur, affecting off-road performance
- 6) Tyres without complete side marking and NHS (= Not for Highway Service) marking cannot be used on normal roads
- 7) Metzeler tubeless (TL) tyres can always be fitted on standard rims with tubes under following conditions:
 - always fit Metzeler tyres with Metzeler tubes only
 - bikes's max speed 230km/h
 - respect all indication of bike manufacturers
- 8) Centrifugal radius measured at 210 km/h
- 9) Centrifugal radius measured at 60 km/h

Your guide to Metzeler's Technology



Steel radial

Innovative belt structure, with a single ply of steel bandinas wrapped at 0° around a radial carcass. Patented technology by Metzeler for both front and rear high performance tires. Steel features a higher stiffness than textile and this allows the reduction of the tyre weight. Steel radial belt reduces the dynamic deformation of the tire under centrifugal forces giving the tyre an excellent high-speed stability. Thanks to the more uniform heat distribution, mileage is increased and wear characteristics are more uniform.

Range: RACETEC™ RR Slick, SPORTEC™ M9RR, SPORTEC™ M7RR, ROADTEC™ 01SE, ROADTEC™ 01, ROADTEC™ Z8 Interact™, CRUISETEC™, ME888 MARATHON™ Ultra, TOURANCE™ NEXT 2, TOURANCE™, KAROO™ Street, KAROO 3™



MAW

"Metzeler Advanced Winding" patented winding system for optimum spacing between the bandinas of the 0° steel belt. Depending on the cross section position, the steel cords are wound with differentiated spacing. On both front & rear tire they're wider in the crown area for more elasticity and self damping, closer in the areas involved in mid leans for improved stiffness during fast cornering. On the shoulder area, but for the rear only, they're again wider for safe feedback and control at grip limit.

Range: All METZELER Steel-belted tires



Multiple radius contour

Engineering technology for contour design dedicated to high performance riding. The contour curvature is differentiated between crown and shoulder area, in order to provide most intuitive and effective handling and grip characteristics. The crown and shoulder areas feature a sharper radius for faster and more precise handling (crown) and safer stability limit feedback (shoulder). A wider radius characterizes the side area, ensuring a larger contact patch for cornering stability.

Range: All METZELER radial tyres



MBS

"Metzeler Belt System" is the patented technology by Metzeler for diagonal belt on conventional tires. This modular-like construction technology really allows tuning each single size to the specific needs of the bikes for superior stability. This means that weight and performance of the tire are specifically developed for classic powerful bikes, enhancing their dynamic performance.

Range: CRUISETEC™, ME888 MARATHON™ Ultra, LASERTEC, ROADTEC™ 01



MBS- Radial

This symbol identifies a tire with radial carcass and diagonal belt, realized with the MBS technology. The radial carcass allows building a low section tire for enhanced cornering stability and reduced weight, while the diagonal belt limits the tire deformations for high speed performance.

Range: CRUISETEC™, ME888 MARATHON™ Ultra



Hyperbase™

This 3D multi-compound tread layout consists in matching a rubber basement underneath the tread rubber layer(s). The basement rubber influences the overall tread rubber dynamic output, and has beneficial effects for line holding and thermal stability, then its duration.

Range: TOURANCE™ NEXT 2, KAROO™ Street



CMT

Advanced design technology of tyre contour tuned on high performance riding style on modern bikes. Front and rear tyre profile matching is optimized through the combination of different profiles, each of them optimized for a single lean angle. The final contour design of the set features the best performing behaviour for every riding style and all modern bikes: predictability, grip limit feedback and cornering stability.

Range: SPORTEC™ M9RR, SPORTEC™ M7RR, ROADTEC™ 01SE, ROADTEC™ 01, ROADTEC™ Z8 Interact™



Dymatec™

Consisting in tread design at the service of functional performance duration, this methodology matches a functional tread design with variable groove wall angles at different lean angles. The result is an optimised wear uniformity by lean angle tailored on the specific application for the whole product lifecycle.

Range: TOURANCE™ NEXT 2



Interact

Multi Zone Tension. Modular steel string winding tension: the performance of the compound depends on the stiffness of the structure. Performance exactly where needed for maximum adaptability to different riding styles.

Range: SPORTEC™ M9RR, SPORTEC™ M7RR, ROADTEC™ 01SE, ROADTEC™ 01, ROADTEC™ Z8 Interact™, CRUISETEC™, TOURANCE™ NEXT 2



Cap&base

This 3D multi-compound tread layout consists in a centre stripe extending underneath the side tread compound(s); the resulting tread dynamic characteristic offers optimal rigidity at all stages of tread lifecycle, and depending on the application it ensures both quick warm-up of tyre shoulder and thermal stability.

Range: SPORTEC™ M9RR, SPORTEC™ M7RR, ROADTEC™ 01SE, ROADTEC™ 01, ROADTEC™ Z8 Interact™, CRUISETEC™, TOURANCE™ NEXT 2



ALL CURVES LEAD TO CRUISETEC™.

THE NEW CRUISETEC™. PERFORMANCE PERFECTED.

The new performance-oriented tyre for V-Twins, designed to upgrade the handling of older and newer motorcycles, featuring remarkable grip in dry and wet conditions, ground-breaking performance consistency and stability features. Discover more on [metzeler.com](https://www.metzeler.com)

METZELER 



CRUISETEC™